



UNITED STATES MARINE CORPS
I MARINE EXPEDITIONARY FORCE
BOX 555300
CAMP PENDLETON CA 92055-5300

IN REPLY REFER TO:

5830

CG

05 APR 2023

SECOND ENDORSEMENT on

ltr 5830 CI of 23 Mar 23

From: Commanding General, I Marine Expeditionary Force

To: File

Subj: COMMAND INVESTIGATION INTO THE CLASS A AVIATION MISHAP THAT OCCURRED ON 8 JUNE 2022 IN THE R-2512 RANGE COMPLEX

1. First and foremost, we mourn the tragic loss of our Marines. On behalf of the Marines and Sailors of I Marine Expeditionary Force, I wish to express my deepest sympathy and condolences to the families, friends, and loved ones of Captain Nicholas P. Losapio, Captain John J. Sax, Corporal Nathan E. Carlson, Corporal Seth D. Rasmuson, and Lance Corporal Evan A. Strickland. These Marines will never be forgotten and will continue to be in our thoughts and prayers.

2. I commend the efforts of the personnel involved in the search, rescue, recovery, and dignified transfer operations. Their diligence, professionalism, and tireless devotion to duty in the midst of difficult and tragic circumstances were truly noteworthy.

3. I concur with the findings of fact, opinions, and recommendations of the investigating officer, as endorsed by the Commanding General, 3d Marine Aircraft Wing. This investigation is closed.

4. The point of contact for this matter is the I MEF Chief of Staff, who can be contacted at

Copy to:

HQMC (DCA, JAD, SAFETY)

CG, 3d MAW



UNITED STATES MARINE CORPS
3D MARINE AIRCRAFT WING, FMF
MARINE CORPS AIR STATION MIRAMAR
P. O. BOX 452022
SAN DIEGO, CALIFORNIA 92145-2022

IN REPLY REFER TO
5830
CG

MAR 30 2023

FIRST ENDORSEMENT on ltr 5830 of 24 Mar 23

From: Commanding General, 3d Marine Aircraft Wing
To: Commanding General, I Marine Expeditionary Force

Subj: COMMAND INVESTIGATION INTO THE CLASS A AVIATION MISHAP THAT
OCCURRED ON 8 JUNE 2022 IN THE R-2512 RANGE COMPLEX

1. I reviewed the subject investigation and concur with the findings, opinions, and recommendations of the Investigating Officer with the following comments:

a. Opinion #7: Concur that the root cause of HCE remains unknown. The implementation of Dynamic Component Bulletin 63 on February 3, 2023 which directed the replacement of all input quill assemblies with over 800 hours has significantly reduced the likelihood of a HCE occurring based on the data provided by Joint Program Management Activity 275. While the likelihood has been significantly reduced, it has not been eliminated. Once the root cause of HCE is understood, then and only then, can improvements to flight control system software, drivetrain component material strength, and robust inspection requirements be developed where applicable.

b. Recommendation #4: Concur provided the Joint Program Management Activity 275 can develop and provide MV-22 ICDS inspection criteria.

2. The tragedy of this event is impossible to capture in words. On behalf of the Marines and Sailors of 3d Marine Aircraft Wing, I send our deepest sympathy and sincerest condolences to the families, friends, and loved ones of Captain Nicholas P. Losapio, Captain John J. Sax, Corporal Nathan E. Carlson, Corporal Seth D. Rasmuson, and Lance Corporal Evan A. Strickland.

3. It is clear from the investigation that there was nothing the crew of SWIFT 11 could have done to anticipate or prevent this aviation mishap. They were engaged in routine flight operations and training, in accordance and compliance with all applicable regulations, when an unanticipated, unrecoverable, and catastrophic mechanical failure occurred.

4. I want to thank the crews of SWIFT 12, WOLFFPACK 11, LANDSLIDE 05, and all first responders who assisted with the response to this mishap, as well as the investigative and engineering teams who assisted in this investigation. Their conduct and professionalism are truly commendatory.

5. The point of contact for this matter is the Staff Judge Advocate of 3d Marine Aircraft Wing,



UNITED STATES MARINE CORPS
3D MARINE AIRCRAFT WING, FMF
MARINE CORPS AIR STATION MIRAMAR
P. O. BOX 452022
SAN DIEGO, CALIFORNIA 92145-2022

IN REPLY REFER TO
5830
CI
23 Mar 23

From: _____, USMC
To: Commanding General, 3d Marine Aircraft Wing, FMF

Subj: COMMAND INVESTIGATION INTO THE CLASS A AVIATION MISHAP THAT OCCURRED ON 8 JUNE 2022 IN THE R-2512 RANGE COMPLEX

Ref: (a) JAGINST 5800.7F
(b) U.S. Code Title 10, Subtitle A, Part IV, Chapter 134, Subchapter II, Section 2255 (Aircraft Accident Investigation Boards)
(c) NAVAIR 01-V22AB-NATOPS Flight Manual Navy Model MV-22B, Jan 20
(d) NAVAIR 01-V22AB-NFM-500 Pilot's/Aircrew Pocket Checklist MV-22B, Jan 20
(e) MV-22 Maneuver Description Guide, Jan 22
(f) OPNAVINST 3510.15B, Air Naval Tactics, Techniques, and Procedures (ANTTP) 3-22.3-MV22, Apr 20
(g) NAVMC 3500.14E CH 1, Aviation Training and Readiness Program Manual
(h) NAVMC 3500.11F MV-22B Training and Readiness Manual, Sep 19
(i) MV-22B Naval Aviation Technical Information Product (NATIP), NTRP 3-22.4 MV22B, Dec 21
(j) COMNAVAIRFOR 3710.7 (NATOPS General Flight and Operating Instructions Manual), May 2016
(k) OPNAVIST 3750.6S (Naval Aviation Safety Program), May 2014
(l) Naval Aviation Maintenance Program (COMNAVAIRFORINST 4790.2D), Feb 2021
(m) SqdnO 3710.0, VMM-364 Special Marine Air Ground Task Force – Crisis Response – Central Command, Deployment Standing Operating Procedures, Mar 21
(n) WgO 3710.39I, 3d MAW Standard Operating Procedures for Air Operations, Apr 22
(o) Naval Aerospace Medical Institute, U.S. Navy Aeromedical Reference and Waiver Guide, Feb 2021
(p) US Department of Transportation, Federal Aviation Administration, Order 7400.10B, Feb 20
(q) Department of the Navy, NAVAIRSYSCOM, PEO(A), PMA-275; V-22 Dynamic Component Bulletin (DCB) 63, Technical Directive Code 52, Proprotor Gearbox Input Quill Assembly Inspection, Feb 23

Encl: (1) Appointing Order from Commanding General (CG), 3d Marine Aircraft Wing, FMF dtd 13 Jun 22
(2) Appointing Order, Mod 1 from CG, 3d Marine Aircraft Wing, FMF dtd 5 Jul 22
(3) Appointing Order, Mod 2 from CG, 3d Marine Aircraft Wing, FMF dtd 2 Aug 22
(4) Authorization of Command Investigation Extension and First Endorsement by CG, 3d Marine Aircraft Wing, FMF dtd 12 Aug 22 and 3 Nov 23

Subj: COMMAND INVESTIGATION INTO THE CLASS A AVIATION MISHAP THAT OCCURRED ON 8 JUNE 2022 IN THE R-2512 RANGE COMPLEX

- (5) 3d Marine Aircraft Wing, and Marine Medium Tiltrotor Squadron 364 (VMM-364) Background Overview
- (6) USMC MV-22B Fact Sheet, Headquarters Marine Corps, Aviation Department, Jun 22
- (7) Commandant of the Marine Corps - Safety Division, MV-22 Comparative Mishap Statistics, July 6, 2022
- (8) Marine Corps Aviation Association Award Citation for 2021 Fred McCorkle Marine Medium Tiltrotor Squadron of the Year
- (9) USMC MV-22B Tail Gunnery Training and Readiness events logged Calendar Year 2012, year to date.
- (10) Line of Duty Preliminary Inquiry into the death of Captain Nicholas P. Losapio, /7532 USMC
- (11) Line of Duty Preliminary Inquiry into the death of Captain John J. Sax, /7532 USMC
- (12) Line of Duty Preliminary Inquiry into the death of Corporal Nathan E. Carlson, /6176 USMC
- (13) Line of Duty Preliminary Inquiry into the death of Corporal Seth D. Rasmuson, /6176 USMC
- (14) Line of Duty Preliminary Inquiry into the death of Lance Corporal Evan A. Strickland, /6176 USMC
- (15) VMM-364 Flight Schedule for 7 June 2022
- (16) VMM-364 Flight Schedule for 8 June 2022
- (17) Aircraft Discrepancy Book for MV-22B BUNO 168018, Tail Number 16
- (18) VMM-364 Aviation Maintenance Supply Readiness Report for 8 June 2022
- (19) VMM-364 Pilot Qualifications and Designations Currency Matrix
- (20) VMM-364 Crew Chief Qualifications and Designations Currency Matrix
- (21) VMM-364 Marine Sierra Hotel Aviation Readiness Program (M-SHARP) Report, Pilot Annual Currency and Proficiency, 30/60/90 and Logbooks
- (22) VMM-364 M-SHARP Report, Crew Chief Annual Currency and Proficiency, 30/60/90 and Logbooks
- (23) Interview Summary, VMM-364 Commanding Officer
- (24) Interview Summary, VMM-364 Aircraft Maintenance Officer
- (25) Interview Summary, VMM-364 Safe for Flight (SFF) Maintenance Controller
- (26) Interview Summary, VMM-364 Mishap Pilot 3
- (27) Interview Summary, VMM-364 Mishap Pilot 4
- (28) Interview Summary, VMM-364 Mishap Crew Chief 4
- (29) Interview Summary, VMM-364 Mishap Crew Chief 5
- (30) Interview Summary, VMM-364 Mishap Crew Chief 6
- (31) Mishap Pilot 1, OPNAVINST 3710.7 (series) Calendar Year 2022 NATOPS Evaluation
- (32) Mishap Pilot 1, 2022 DD Form 2992, Medical Recommendation for Flying or Special Operational Duty (Up-Chit), 7 Mar 2022
- (33) Mishap Pilot 1, Qualification for Duty Involving Flying, Naval Aerospace Medical Institute, 10 Dec 2012
- (34) Mishap Pilot 1, Qualification for Duty Involving Flying, USMC Recruiting Command, 11 Dec 2012

Subj: COMMAND INVESTIGATION INTO THE CLASS A AVIATION MISHAP THAT OCCURRED ON 8 JUNE 2022 IN THE R-2512 RANGE COMPLEX

- (35) Mishap Pilot 2, OPNAVINST 3710.7 (series) Calendar Year 2022 NATOPS Evaluation
- (36) Mishap Pilot 2, 2022 DD Form 2992, Medical Recommendation for Flying or Special Operational Duty (Up-Chit), 4 Feb 2022
- (37) Mishap Pilot 2, Qualification for Duty Involving Flying, Naval Aerospace Medical Institute, 17 Nov 2015
- (38) Mishap Pilot 2, Qualification for Duty Involving Flying, USMC Recruiting Command, 16 Dec 2015
- (39) Mishap Crew Chief 1, OPNAVINST 3710.7 (series) Calendar Year 2022 NATOPS Evaluation
- (40) Mishap Crew Chief 1, 2022 DD Form 2992, Medical Recommendation for Flying or Special Operational Duty (Up-Chit), 21 Mar 2022
- (41) Mishap Crew Chief 2, OPNAVINST 3710.7 (series) Calendar Year 2022 NATOPS Evaluation
- (42) Mishap Crew Chief 2, 2022 DD Form 2992, Medical Recommendation for Flying or Special Operational Duty (Up-Chit), 29 Apr 2022
- (43) Mishap Crew Chief 3, OPNAVINST 3710.7 (series) Calendar Year 2022 NATOPS Evaluation
- (44) Mishap Crew Chief 3, 2022 DD Form 2992, Medical Recommendation for Flying or Special Operational Duty (Up-Chit), 2 Mar 2022
- (45) Mishap Section Mission Flight Brief for 8 Jun 2022
- (46) VMM-364 Operations Duty Officer Flight Brief, 8 Jun 2022
- (47) Visual Military Training Route 1268 (VR-1268) Special Operating Procedures, 8 Jun 2022
- (48) Visual Military Training Route 289 (VR-289) Special Operating Procedures, 8 Jun 2022
- (49) Mishap Section, Smart-Pack Cover Page (inflight reference), 8 Jun 2022
- (50) Mishap Section, Navigation Log Route Card #1, MCAS Camp Pendleton to Lake Havasu City Municipal Airport, 8 Jun 2022
- (51) Mishap Section, Navigation Log Route Card #2, Lake Havasu City Municipal Airport to MCAS Camp Pendleton, 8 Jun 2022
- (52) Mishap Section, Aircraft Weight and Balance Load Computation, 8 Jun 2022
- (53) Mishap Section, Take Off and Landing Distance Computation, 8 Jun 2022 Computation, 8 Jun 2022
- (54) Mishap Section, Landing Zone Rice diagram, 8 Jun 2022
- (55) Mishap Aircraft 1, Risk Assessment Worksheet, 8 Jun 2022
- (56) Yuma Range Aircrew Safety Brief, 23 Jun 2017
- (57) VMM-364 Operations Duty Officer Logbook Entry, 8 Jun 2022
- (58) Range R-2512, Inky Barley Elevation Analysis
- (59) Imperial County Weather Observation, 8 Jun 2022
- (60) Range R-2512 Solar and Lunar Almanac Prediction, 8 Jun 2022
- (61) 84th Radar Evaluation Squadron Data Reduction for Navy Safety Command, 8 Jun 2022
- (62) Mishap Section Tail Gunnery Operations Objective Area Diagram, 8 Jun 2022
- (63) Mishap Aircraft 1 Radar Position Data, 8 Jun 2022
- (64) Mishap Section Radar Location Data, 8 Jun 2022

Subj: COMMAND INVESTIGATION INTO THE CLASS A AVIATION MISHAP THAT OCCURRED ON 8 JUNE 2022 IN THE R-2512 RANGE COMPLEX

- (65) Mishap Aircraft 1 Crash Site Graphic, 8 Jun 2022
- (66) Mishap Aircraft 1 Crash Site Photo, 9 Jun 2022
- (67) VMM-364 Mishap Investigation Support Team In-field Investigation Report, MV-22B BUNO 168018, 8 Jun 2022

- (69) Mishap Aircraft 2 On-Scene Commander Notes for 8 Jun 2022
- (70) HSC-3, Landslide 05 Timeline of Post-Crash Events on 8 Jun 2022
- (71) VMM-364 Operations Duty Officer Mishap Logbook Entries for 8 Jun 2022
- (72) Interview Summary, HMMH-466 Wolfpack 11, Section Leader
- (73) Interview Summary, HMMH-466 Wolfpack 11, Crew Chief
- (74) Interview Summary, HMMH-466 Wolfpack 11, Aerial Observer
- (75) Interview Summary, HSC-3 Landslide 05, Helicopter Aircraft Commander
- (76) HMMH-466 Squadron Flight Schedule for 8 Jun 2022
- (77) HSC-3 Naval Air Facility (NAF) El Centro Detachment Flight Schedule for 8 Jun 2022

- (79) AFSOC CV-22 Safety Stand Down and Return to Flight Operations Articles, *Air and Space Forces Magazine*, <https://www.airandspaceforces.com/afsoc-grounds-cv-22-osprey-fleet-over-safety-issue/>, 17 Aug 2022
- (80) U.S. Naval Safety Command, USMC MV-22B Consolidated HAZREP Data from Jun 2000 to May 2022
- (81) U.S. Naval Safety Command, USMC MV-22B Consolidated Class A, B, and C Mishap Data from Jun 2000 to May 2022

- (83) Naval Air Systems Command Average Aircraft Investment Costs for 2018, 21 Aug 2018
- (84) Listing of Personnel associated with the VMM-364 MV-22B Class A Mishap that occurred on 8 Jun 2022 in the R-2512 Range Complex

Preliminary Statement

1. In accordance with reference (a), this report marks the completion of the command investigation conducted into the facts and circumstances surrounding the aviation mishap with aircraft assigned to Marine Medium Tiltrotor Squadron 364 (VMM-364), MV-22B BUNO 168018, call-sign Swift 11, Mishap Aircraft 1 (MA1) that occurred on 8 June 2022 in the R-2512 range complex near El Centro, California.

2. The Investigating Officer (IO) collected all reasonably available evidence for this investigation, met each convening authority directive stated in Encl (1), and adhered to all governing regulations. _____, USMC, Staff Judge Advocate for the 3d Marine Aircraft Wing (3d MAW), _____, USMC, Staff Judge

Subj: COMMAND INVESTIGATION INTO THE CLASS A AVIATION MISHAP THAT OCCURRED ON 8 JUNE 2022 IN THE R-2512 RANGE COMPLEX

Advocate for 3d MAW and
MAW, provided legal support.

, USMC, Assistant Staff Judge Advocate for 3d

3. Prior to questioning witnesses, the IO advised them of the purpose of the JAGMAN investigation and reasons for apparent duplication of effort with the Aircraft Mishap Board (AMB) in accordance with reference (a) and enclosure (1). All applicable personnel and witnesses cooperated fully with this investigation. No personnel interviewed in the course of this investigation were suspected of an offense under the Uniform Code of Military Justice; therefore, no recitation of Article 31(b) rights was deemed necessary.

4. Analysis from the U.S. Navy Air Combat Electronics Program Office (PMA-209) determined the MA1 Flight Data Recorder was not reasonably available due to crash damage. Additionally, future expenses attributed to property and environmental damages were not reasonably available as of the date of submission. All expenses included in the report relating to damages were actually incurred without projection for future costs.

5. In accordance with enclosures 10 through 14, a line of duty determination was made that the deaths of the five crew members of MA1 were in the line of duty, not due to the members' misconduct. The families were notified of this determination and that additional investigative steps were initiated by the Commanding General, 3d MAW on 29 June 2022, (Encl 10 through 14). Although no injury was identified, the crew members of Wolfpack 11/12, a CH-53E section from Marine Heavy Helicopter Squadron 466 (HMH-466) and the crew members of Landslide 05, a single MH-60S from Navy Helicopter Sea Combat Squadron Three (HSC-3) are identified in enclosure 83 to ensure appropriate documentation of any potential injury that resulted from their presence at the MA1 crash site.

6. Enclosures 5 through 84 contain material pertinent to this investigation. I certify that all enclosures are original true copies or true and accurate copies of the original documents they represent.

7. All times in this report are local Pacific Daylight Time (PDT) unless otherwise annotated.

8. All times are approximate based on the IO's analysis of witness statements, radar data, and Mishap Aircraft 2 (MA2) position, navigation, and timing data.

9. All photographs listed in the enclosures were taken by members of the AMB on or about 9 June 2022 at the mishap site.

10. Original items of evidence are in the custody of the AMB.

11. In anticipation of requests for release of the investigation pursuant to the Freedom of Information Act (FOIA), the names of personnel involved are not listed within the body of the investigation but are found in enclosure 84.

12. The IO focused on eight areas while investigating facts and circumstances pertaining to what happened prior to, during, and immediately after the 8 June 2022 aviation mishap: 1) MV-

Subj: COMMAND INVESTIGATION INTO THE CLASS A AVIATION MISHAP THAT OCCURRED ON 8 JUNE 2022 IN THE R-2512 RANGE COMPLEX

22B platform overview, 2) unit and mission background, 3) aircraft readiness and/or ability to complete the assigned mission, 4) aircrew readiness and/or ability to complete the assigned mission, 5) MA1 mishap timeline 6) MA1 post-mishap events, 7) relevant procedures and evidence, and 8) overall damages caused by the mishap.

13. There were no direct witnesses of the mishap and due to the intensity of the post-crash fire, the MA1 crash-survivable data recorder was not recoverable. Available data sources include radar analysis of the Mishap Section (MS) flight path, indirect witness statements from MA2, a crash site survey, an Engineering Investigation (EI) from the Fleet Support Team (FST), Fleet Readiness Center – East (FRC-E) and a flight path reconstruction from the Naval Air Warfare Center Aircraft Division Aeromechanics Safety Investigation Support Team (ASIST). Due to the severity of the post-crash fire and damage to dynamic components the EIs conducted by the FST required in depth metallurgical and engineering analysis which were not complete until 17 March 23.

14. The IO evaluated procedural evidence and directives related to MV-22B tail gunnery (TG) operations using the ramp-mounted weapons system (RMWS). The IO reviewed Naval Service Training and Readiness Manuals and tactics publications to gain a comprehensive understanding of TG and RMWS roles, responsibilities, and the procedures used on 8 June 2022 within the R-2512 Range Complex. The IO researched aircrew readiness with information provided by VMM-364, the Marine-Sierra Hotel Aviation Reporting Program (M-SHARP), squadron and community MV-22B Standard Operating Procedures (SOPs), along with Naval Aviation MV-22B aircrew currency regulations. A limited scope trend analysis on historical data from the U.S. Naval Safety Command was conducted to gain a historical perspective on mishaps of this nature. For aircraft readiness, the IO reviewed digital and printed records from the VMM-364 maintenance systems. The IO relied upon weather briefing material, aircrew interviews, and forecast weather to ascertain the environmental effects to the MS RMWS/TG operations within the R-2512 Range Complex immediately prior to and during the time of the mishap.

15. The Command Investigation team was comprised of, in part, two pilots with a combined total of over 30 years of flying experience, and over 3400 flight hours, over 400 of which were on the MV-22B platform. One of the pilots is a former training squadron commander, the other a certified MV-22B Aviation Safety Officer. The investigation team's methodology was to evaluate in detail the potential causes of the mishap using possible scenarios, which allowed for an exploration of the available evidence and development of conclusions through a process of elimination. The available data and analysis indicate that the root cause of the mishap was a dual hard clutch engagement (HCE) that created a Single Engine and Interconnect Drive System (Single Engine/ICDS) failure resulting in a catastrophic loss of thrust on the right-hand (RH) propotor. The degraded drivetrain caused by the dual HCE event and subsequent Single Engine/ICDS failure created an unrecoverable departure from controlled flight and the tragic crash that occurred on 8 June 2022.

Findings of Fact

MV-22B Platform Overview

Subj: COMMAND INVESTIGATION INTO THE CLASS A AVIATION MISHAP THAT OCCURRED ON 8 JUNE 2022 IN THE R-2512 RANGE COMPLEX

1. The MV-22 Osprey is a tiltrotor aircraft, built by Bell Helicopter Textron and Boeing Integrated Defense Systems. The tiltrotor design combines the Vertical Takeoff and Landing (VTOL) capabilities of a helicopter with the speed, range, and service ceiling of a turboprop airplane. The aircraft is a twin engine, twin proprotor, high wing, twin tail design with retractable landing gear. The proprotor system and airframe are primarily constructed of lightweight composite materials. [Ref (c)]
2. The MV-22B, CV-22 and MCV-22B engines, proprotor gearboxes (PRGB) and tilt-axis gearboxes (TAGB) are integrated into each of the left and right-hand nacelles mounted on the wingtips. [Ref (c)]
3. The nacelles are mounted on the wing such that when the nacelles are positioned at 90 degrees (helicopter mode) there is a 2.5-degree outward tilt of the mast and when the nacelles are positioned at 0 degrees (airplane mode) the nacelles are parallel to the fuselage. The aircraft utilizes a “fly-by-wire” flight control system, with mechanical linkages limited to the cockpit area (Figure 1). [Ref (c)]

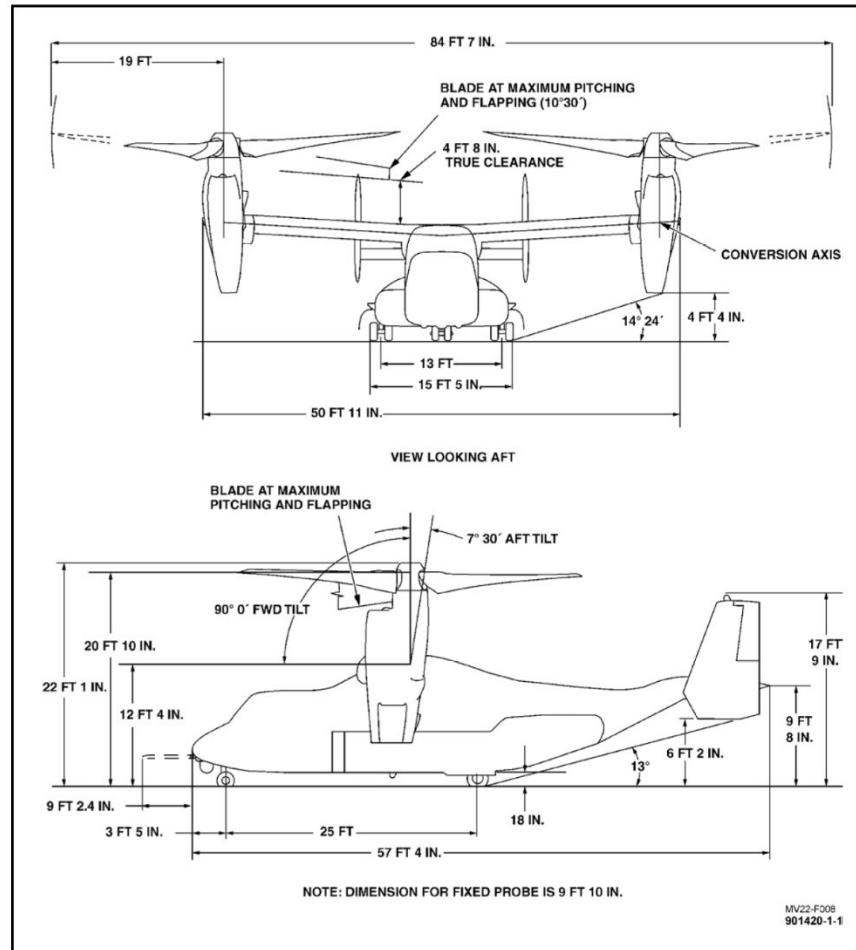

Figure 1

Subj: COMMAND INVESTIGATION INTO THE CLASS A AVIATION MISHAP THAT OCCURRED ON 8 JUNE 2022 IN THE R-2512 RANGE COMPLEX

4. The MV-22B is powered by two Rolls-Royce Corporation AE1107C turboshaft engines. One engine is mounted in each of the wingtip nacelles. The 6,150 shaft horsepower engine consists of four major assemblies: the torque meter assembly, the gas generator assembly, the power turbine assembly, and the accessory drive gearbox. [Ref (c)]
5. The torque meter assembly, located on the front of the engine, transmits engine output power, measures engine output power in terms of torque, provides the front engine mount, and provides a secondary power turbine shaft speed (Np) measurement. [Ref (c)]
6. Output power is transferred from the engine to Proprotor Gearboxes (PRGBs) by the torque shaft, located in the center of the torque meter assembly. Torque is measured by two monopole torque sensors, which generate an electrical signal that is monitored by the Full Authority Digital Engine Controls (FADECs). The FADECs convert the signals into a torque measurement. [Ref (c)]
7. Engine shutdown with a FADEC in control is defined as a controlled shutdown. The controlling FADEC initiates a shutdown sequence when an engine overspeed, overtemperature, or start error condition occurs. [Ref (c)]
8. Each nacelle has an Engine Air Particle Separator (EAPS) that assures a relatively clean flow of air into the engine by removing particles that could damage engine components before they reach the compressor section of the engine. [Ref (c)]
9. Functioning EAPS are required to conduct reduced visibility landings (RVLs) or landings in unimproved landing zones that likely contain dust, dirt, and other particles that could degrade engine performance. [Ref (c)]
10. The MV-22B has two PRGBs, one mounted in each nacelle, which transmit power and provide a speed reduction from the engine to the proprotor mast. The lower aft portion of each

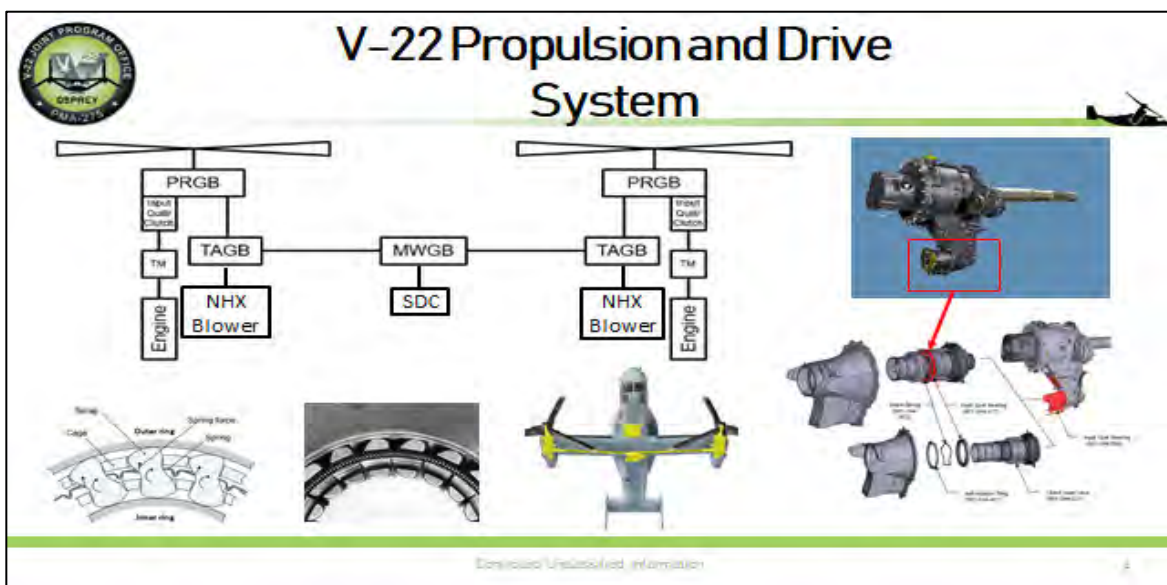

Figure 2

Subj: COMMAND INVESTIGATION INTO THE CLASS A AVIATION MISHAP THAT OCCURRED ON 8 JUNE 2022 IN THE R-2512 RANGE COMPLEX

PRGB provides the forward mount for each corresponding engine. The engine output shaft drives the first stage input gear train through an overrunning clutch in the input quill. The clutch within the input quill transmits engine torque during normal operation and permits overrunning during single engine operation, autorotation, or if engine speeds are not matched (Figure 2). [Ref (c)]

11. The MV-22B has an Interconnect Drive System (ICDS) that runs through the wings to synchronize the proprotors and transfer power between the proprotor systems and all accessory equipment. If one engine fails, the ICDS transmits power to the PRGB on the side of the failed engine. [Ref (c)]

12. The ICDS is the only means of providing power to both PRGBs in the event of single engine failure, providing power from the single operating engine to both PRGBs. [Ref (c)]

13. The failure of an engine and the ICDS creates an asymmetric power condition that requires immediate response to regain control. The failure will cut off power to one rotor creating an asymmetry as the functioning engine can only drive one rotor to generate thrust. If the functioning engine is not secured, control may be lost as the unbalanced rotor thrust can quickly result in loss of aircraft control if immediate and appropriate pilot action is not taken. [Ref (c)]

14. The first of three MV-22B flight modes is called Vertical Takeoff/Landing (VTOL) mode: Flight operations with the nacelles set between 85° and the aft stop (approximately 96°). [Ref (c)]

15. The second MV-22B flight mode is called Conversion (CONV) mode: Flight operations with the nacelles set between 1° and 84°. [Ref (c)]

16. The third MV-22B flight mode is called Airplane (APLN) mode: Flight operations with the nacelles on the down-stops (0° nacelles). [Ref (c)]

17. As of 1 April 2022, the Marine Corps and Navy have logged a total of 422,165 flight hours on the MV-22 platform since 2012. [Enc (7)]

18. There have been 14 Class A (catastrophic) flight and ground related mishaps for the MV-22 platform in the Marine Corps since 2012. [Enc (7, 80, 81)]

19. The 10-year average mishap rate for USMC MV-22B is 3.16 per 100,000 flight hours [Encl (7)]

20. The USMC aviation mishap average is 3.1 per 100,000 flight hours, which includes aircraft such as AV-8B, F/A-18A-C, F-35B, CH-53E, and KC-130J. [Encl (7)]

21. Naval Safety Command Class A-C mishap and Hazard Report data from April 2000 to May 2022 shows no record of a MV-22B, CV-22, or CMV-22B Single Engine/ICDS Failure compound emergency or mishap. [Enc (7, 80, 81)]

Subj: COMMAND INVESTIGATION INTO THE CLASS A AVIATION MISHAP THAT OCCURRED ON 8 JUNE 2022 IN THE R-2512 RANGE COMPLEX

22. From January 2012 to July 2022 USMC MV-22B pilots and aircrew flew over 35,000 successful MV-22B Tail Gunnery (TG) Training and Readiness mission sortie codes. [Encl (7)]

23. Prior to 8 June 2022 there has been no loss of life resulting from an HCE event or related compound emergency within the joint V-22 community. [Encl (7, 78, 80, 81)]

Unit and Mission Background

24. The United States Marine Corps (USMC) has 18 MV-22B Squadrons, consisting of 15 Operational Active Component squadrons, two Reserve Component Squadrons, and one Training squadron. [Encl (6)]

25. USMC MV-22B squadrons consist of approximately 12-14 MV-22B aircraft, and approximately 200 personnel. [Enc (6, 23)]

26. As expeditionary units, MV-22B squadrons contain pilots and Crew Chiefs who fly the aircraft and maintenance and support personnel who maintain the aircraft and support flight operations. [Enc (6, 23)]

27. VMM-364 is one of the seven flying squadrons that comprise Marine Aircraft Group 39, based at Marine Corps Air Station (MCAS) Camp Pendleton. [Encl (5)]

28. VMM-364 consists of approximately 200 Marines and Sailors, and 14 MV-22B tiltrotor aircraft. [Enc (23)]

29. The mission of a Marine Medium Tiltrotor Squadron is to support the Marine Air-Ground Task Force (MAGTF) commander by providing assault support transport of combat troops, supplies and equipment—day and night—under all weather conditions during expeditionary, joint, or combined operations. [Ref (f)]

30. VMM-364 was deployed in support of Special Marine Air Ground Task Force – Crisis Response – Central Command from March 2021 – October 2021. [Encl (5)]

31. VMM-364 was awarded the Fred McCorkle Marine Medium Tiltrotor Squadron of the Year by the Marine Corps Aviation Association for superior performance in direct support of combat operations, risk management and surpassing the 10,000 flight hour mishap-free milestone with a 100% mission success rate from 1 January 2021 to 31 December 2021 [Encl (8)]

32. On 8 June 2022 VMM-364 had 14 aircraft assigned, 10 aircraft in reporting and available for squadron maintenance or flight operations, and 4 aircraft out of reporting and not available for squadron maintenance or flight operations. Of the 10 aircraft in reporting, one was Full Mission Capable (FMC), 5 were Partial Mission Capable (PMC), and four were Not Mission Capable (NMC) yielding 60% aircraft readiness. [Encl (18)]

MA1, MV-22B BUNO 168018 (Tail Number 16)

Subj: COMMAND INVESTIGATION INTO THE CLASS A AVIATION MISHAP THAT OCCURRED ON 8 JUNE 2022 IN THE R-2512 RANGE COMPLEX

33. MA1, MV-22B BUNO 168018, MODEX (Tail Number) 16, had 2007.1 total flight hours prior to 8 June 2022 and was last flown on 6 June 2022. [Encl (17)]
34. MA1 was properly released for flight and certified in accordance with reference (1) by the appropriate VMM-364 Safe for Flight (SFF) Certified Maintenance Controller. [Encl (17, 25)]
35. Prior to launch, Mishap Pilot 1 (MP1) reviewed the MA1 aircraft discrepancy book and digitally signed for the aircraft, indicating that he thoroughly reviewed the maintenance history of the aircraft and its preparation for the tasked mission. [Encl (17, 25)]
36. There were no uncompleted maintenance actions or Time Critical Technical Directives (TCTD) that reasonably could be considered to have influenced or caused the mishap. [Encl (17, 25)]
37. There were no high time components that failed by exceeding mean-time-between failure rates that could be considered to have influenced or caused the mishap. [Encl (17, 25)]
38. All components installed on the aircraft were correct according to required parts, material, inspection, and maintenance procedure specifications. [Encl (17)]
39. There were eight partial mission capable degrader discrepancies, or “partials,” on MA1: three of these partials concerned the icing system; one concerned the shear gage on the left green blade for Blade Fold operations; one concerned intermittent and repeated postings of failed contactors on the fourth generator; one concerned the Active Vibration Suppression System (AVSS). Finally, the EAPS for the Left Hand (LH) Engine was inoperable. The partials were understood and accepted by MP1. [Encl (17, 25)]
40. MP1 was briefed that the LH Engine EAPS failure meant that the MA1 should not conduct reduced visibility landings (RVLs) during the flight on 8 June 2022. [Encl (25)]
41. MA1 and MA2 EAPS discrepancies caused the MS to modify training objectives by omitting RVLs. [Encl (26-30)]
42. There is no evidence that maintenance malpractice or component material condition influenced or caused the mishap. [Encl (17, 25)]
43. Prior to 8 June 2022, MA1 LH Proprotor Gearbox Input Quill Assembly accrued a reported 2437 Time Since New (TSN) flight hours and 1094 Time Since Repair (TSR) flight hours. [Encl (68)]
44. MA1 RH Proprotor Gearbox Input Quill Assembly accrued a reported 2007.1 TSN flight hours prior to 8 June 2022. [Encl (68)]

Mishap Pilot 1

Subj: COMMAND INVESTIGATION INTO THE CLASS A AVIATION MISHAP THAT OCCURRED ON 8 JUNE 2022 IN THE R-2512 RANGE COMPLEX

45. MP1 was the MA1 Tiltrotor Aircraft Commander (TAC), and designated Section Leader for the MS on 8 June 2022. [Encl (16)]

46. On 8 June 2022, MP1 was on active duty in the Regular Marine Corps. [Enc 10]

47. MP1 completed an annual flight physical on 7 March 2022, with an expiry of 31 March 2023. MP1 had a current and valid DD FORM 2992 or "Up Chit" certifying medical clearance for aviation duty on 8 June 2022. [Encl (32)]

48. MP1 had one aeromedical waiver for concussion/traumatic brain injury in 2012 and was approved for duty in direct actual control of aircraft by the Naval Aerospace Medical Institute (NAMI). Each year the NAMI flight waiver is evaluated during an annual flight physical by a U.S. Navy Flight Surgeon to determine if the waiver remains valid. The VMM-364 Squadron Flight Surgeon made a note on MP1's DD FORM 2992, "recommend continue waiver" indicating that MP1 was fit for Duty Involving Flight Operations on 8 June 2022. [Ref (o), Encl (32-34)]

49. MP1 was not prescribed any medications on 8 June 2022 per the military health system. [Encl (32)]

50. MP1 did not indicate human factors or life stressors to any member of the MS prior to launch on 8 June 2022. [Encl (23, 26-30)]

51. MP1's last flight prior to 8 June 2022 was on 2 June 2022, for a 1.0 hour day familiarization proficiency sortie. [Encl (21)]

52. MP1 was a highly qualified and experienced MV-22B instructor pilot whose total flight time was 1648.5, with 1450.6 hours in the MV-22B, 639.7 hours as an MV-22B TAC, 183.3 hours flown in combat, and 237.3 hours as an MV-22B Section Leader. [Encl (19, 21)]

53. MP1 was current, qualified, and proficient to conduct the assigned mission on 8 June 2022. [Encl (19, 21)]

54. MP1 conducted a NATOPS evaluation open book test, closed book test, and check flight per OPNAV 3710/7 and was determined to be well qualified to serve as the VMM-364 NATOPS Instructor on 22 February 2022. [Encl (31)]

55. On 8 June 2022, MP1's flight hours within the previous 30 days, 60 days, and 90 days were 30.9 (10 May 2022), 37.9 (11 April 2022), and 49.9 (12 March 2022). [Encl (21)]

56. In addition to providing planning guidance and preparation oversight of Mishap Pilot 3 (MP3) who was the Section Leader Under Instruction (SLUI) on 8 June 2022, MP1 was on the 7 June 2022 flight schedule for a standby flight, but that flight was not executed. [Encl (15, 23)]

Subj: COMMAND INVESTIGATION INTO THE CLASS A AVIATION MISHAP THAT OCCURRED ON 8 JUNE 2022 IN THE R-2512 RANGE COMPLEX

57. There were no indications that MP1 was involved in preflight planning or mission preparations that caused him to work late or remain at the squadron in a manner that violated required crew rest on the evening of 7 June 2022. [Encl (15, 26-27)]

Mishap Pilot 2

58. Mishap Pilot 2 (MP2) was the Tiltrotor Second Pilot (T2P) of MA1 on 8 June 2022. [Encl (16)]

59. On 8 June 2022, MP2 was on active duty in the Regular Marine Corps. [Enc (11)]

60. MP2 completed an annual flight physical on 4 February 2022, with an expiry 31 August 2023. MP2 had a current and valid DD FORM 2992 or "Up Chit" certifying medical clearance for aviation duty on 8 June 2022. [Encl (36)]

61. MP2 had one aeromedical waiver for Lasik eye surgery in 2015 and was approved for duty in direct actual control of aircraft by the Naval Aerospace Medical Institute (NAMI). Each year the NAMI flight waiver is evaluated during an annual flight physical by a US Navy Flight Surgeon to determine if the waiver remains valid. The VMM-364 Squadron Flight Surgeon made a note on MP2's DD FORM 2992, "recommend continue waiver" indicating that MP2 was fit for Duty Involving Flight Operations. [Ref (o), Encl (36-38)]

62. MP2 was prescribed fluoride toothpaste, but no other medications on 8 June 2022 per the military health system. [Encl (36)]

63. MP2 did not indicate human factors or life stressors to any member of the MS prior to launch on 8 June 2022. [Encl (26-30)]

64. MP2's last flight prior to 8 June 2022 was on 6 June 2022, for 2.3 hours of High-Light Level (HLL) night single ship Confined Area Landings (CALs) and section tactical CALs followed by an introduction to HLL Tail Gunnery sortie. [Encl (21)]

65. MP2 was new to the squadron but assessed to be a talented MV-22B pilot whose total flight time was 513.9, with 235.1 hours in the MV-22B, and 65.8 hours as an MV-22B T2P. [Encl (21, 23)]

66. MP2 was current, qualified, and proficient to conduct the assigned mission on 8 June 2022. [Encl (19, 21)]

67. MP2 conducted a NATOPS evaluation open book test, closed book test, and check flight per OPNAV 3710/7 and was determined to be well qualified to hold the T2P designation on 6 May 2022. [Encl (35)]

68. On 8 June 2022, MP2's flight hours within the previous 30 days, 60 days, and 90 days were 6.8 (10 May 2022), 24.8 (11 April 2022), and 31.1 (12 March 2022). [Encl (21)]

Subj: COMMAND INVESTIGATION INTO THE CLASS A AVIATION MISHAP THAT OCCURRED ON 8 JUNE 2022 IN THE R-2512 RANGE COMPLEX

69. In addition to conducting planning requirements for MA1 and providing planning support for MP3's SLUI the next day, MP2 attended a Marine Corps Ball Committee Meeting from 1530-1630 on 7 June 2022. [Encl (15)]

70. There were no indications that MP2 was involved in preflight planning or other duties that caused him to work late or remain at the squadron in a manner that violated required crew rest on the evening of 7 June 2022. [Encl (15, 26-27)]

Mishap Crew Chief 1

71. Mishap Crew Chief 1 (MCC1) was the designated Crew Chief Low Altitude Tactics Instructor (LATI) for MA1 and was assigned to provide instruction to Mishap Crew Chief 2 (MCC2) for Low Altitude Tactics (LAT) and Mishap Crew Chief 3 (MCC3) for CALs on 8 June 2022. [Encl (16)]

72. On 8 June 2022, MCC1 was on active duty in the Regular Marine Corps. [Encl (12)]

73. MCC1 completed an annual flight physical on 21 March 2022, with an expiry of 31 March 2023. MCC1 had a current and valid DD FORM 2992 or "Up Chit" certifying medical clearance for aviation duty on 8 June 2022. [Encl (40)]

74. MCC1 had no aeromedical waivers but was not cleared for flight duty until a month after his flight physical due to a temporary medical disqualification for lower back pain. On 31 March 2022, MCC1 was cleared for Duty Involving Flight Operations by the VMM-364 Squadron Flight Surgeon. [Encl (40)]

75. MCC1 was not prescribed any medications on 8 June 2022 per the military health system. [Encl (40)]

76. MCC1 did not indicate human factors or life stressors to any member of the MS prior to launch on 8 June 2022. [Encl (26-30)]

77. MCC1's last flight prior to 8 June 2022 was on 6 June 2022, for a 4.5 hour section tactical CALs followed by day Tail Gunnery (TG), and a Gun Aircraft Unit-21 (GAU-21) .50 caliber machinegun qualification check sortie. [Encl (22)]

78. MCC1 was a junior but skilled MV-22B Crew Chief Instructor whose total flight time was 585.7 MV-22B hours, with 74.0 hours flown in combat. [Encl (22)]

79. MCC1 was current, qualified and proficient to conduct the assigned mission on 8 June 2022. [Encl (20, 22)]

80. MCC1 conducted a NATOPS evaluation open book test, closed book test, aircraft egress, Crew Resource Management (CRM), and NATOPS check flight per OPNAV 3710/7 and was determined to be well qualified to hold the designation of MV-22B Crew Chief on 3 March 2022. [Encl (39)]

Subj: COMMAND INVESTIGATION INTO THE CLASS A AVIATION MISHAP THAT OCCURRED ON 8 JUNE 2022 IN THE R-2512 RANGE COMPLEX

81. On 8 June 2022, MCC1's flight hours within the previous 30 days, 60 days, and 90 days were 30.5 (10 May 2022), 66.5 (11 April 2022), and 81.0 (12 March 2022). [Encl (22)]

82. MCC1 was on the day maintenance shift schedule for 6-7 June 2022 and ended his day maintenance shift on the afternoon of 7 June 2022. [Encl (28-30)]

83. There were no indications that MCC1 was involved in maintenance or other duties that caused him to work late or remain at the squadron in a manner that violated required crew rest on the evening of 7 June 2022. [Encl (24, 28-30)]

Mishap Crew Chief 2

84. MCC2 was the designated LATI under instruction for MA1 on 8 June 2022. [Encl (16)]

85. On 8 June 2022, MCC2 was on active duty in the Regular Marine Corps. [Encl (13)]

86. MCC2 completed an annual flight physical on 29 April 2022, with an expiry of 30 April 2023. MCC2 had a current and valid DD FORM 2992 or "Up Chit" certifying medical clearance for Duty Involving Flight Operations by the VMM-364 Squadron Flight Surgeon on 8 June 2022. [Encl (42)]

87. MCC2 was not prescribed any medications on 8 June 2022 per the military health system. [Encl (42)]

88. MCC2 did not indicate human factors or life stressors that would degrade or cause distraction to his performance while conducting the mission to any member of the MS prior to launch on 8 June 2022. [Encl (26-30)]

89. MCC2's last flight prior to 8 June 2022 was on 2 June 2022, for a 5.0 hour section tactical CALs followed by day TG, and a M240D 7.62mm caliber machinegun qualification check sortie. [Encl (22)]

90. As with MCC1, MCC2 was a relatively junior but talented MV-22B Basic Instructor Crew Chief whose total flight time was 529.7 MV-22B hours, with 72.0 hours flown in combat. [Encl (22)]

91. MCC2 was qualified and proficient to conduct the assigned mission on 8 June 2022. [Encl (20, 22)]

92. MCC2 conducted a NATOPS evaluation open book test, closed book test, aircraft egress, CRM, and NATOPS check flight per OPNAV 3710/7 and was determined to be well qualified to hold the designation of MV-22B Crew Chief on 30 July 2021. [Encl (41)]

93. On 8 June 2022, MCC2's flight hours within the previous 30 days, 60 days, and 90 days were 38.7 (10 May 2022), 72.7 (11 April 2022), and 104.7 (12 March 2022). [Encl (22)]

Subj: COMMAND INVESTIGATION INTO THE CLASS A AVIATION MISHAP THAT OCCURRED ON 8 JUNE 2022 IN THE R-2512 RANGE COMPLEX

94. MCC2 was on the day maintenance shift schedule for 6-7 June 2022 and ended his day maintenance shift on the afternoon of 7 June 2022. [Encl (28-30)]

95. There were no indications that MCC2 was involved in maintenance or other duties that caused him to work late or remain at the squadron in a manner that violated required crew rest on the evening of 7 June 2022. [Encl (24, 28-30)]

Mishap Crew Chief 3

96. MCC3 was the designated Crew Chief under instruction for day LAT and CALs as part of MA1 Aircrew (MC1) on 8 June 2022. [Encl (16)]

97. On 8 June 2022, MCC3 was on active duty in the Regular Marine Corps. [Encl (14)]

98. MCC3 completed an annual flight physical on 29 April 2022, with an expiry of 30 April 2023. MCC2 had a current and valid DD FORM 2992 or "Up Chit" certifying medical clearance for Duty Involving Flight Operations by the VMM-364 Squadron Flight Surgeon on 8 June 2022. [Encl (44)]

99. MCC3 was not prescribed any medications on 8 June 2022 per the military health system. [Encl (44)]

100. MCC3 did not indicate human factors or life stressors that would degrade or cause distraction to his performance while conducting the mission to any member of the MS prior to launch on 8 June 2022. [Encl (26-30)]

101. MCC3's last event prior to 8 June 2022 was on 26 May 2022 in the MV-22B Marine Common Aircrew Trainer simulator for a 2.0 hour reduced visibility CALs introduction, and day/night field carrier landing practice training events. [Encl (22)]

102. MCC3's last flight in the aircraft prior to 8 June 2022 was on 19 April 2022 for his first annual NATOPS check, during which he conducted a NATOPS evaluation open book test, closed book test, aircraft egress, CRM, and NATOPS check flight per OPNAV 3710/7 and was determined to be well qualified to hold the designation of MV-22B Crew Chief on 19 April 2022. [Encl (22, 43)]

103. MCC3 was new to the squadron and had a total flight time of 65.8 MV-22B hours. [Encl (20, 22)]

104. MCC3 was qualified to conduct the assigned mission on 8 June 2022, but he was not current or proficient. He was authorized to fly the mission for initial training events in day LAT and CALs under the instruction of MCC1. [Encl (16, 20, 22)]

105. On 8 June 2022, MCC3's flight hours within the previous 30 days, 60 days, and 90 days were 4.0 (10 May 2022), 21.0 (11 April 2022), and 41.7 (12 March 2022). [Encl (22)]

Subj: COMMAND INVESTIGATION INTO THE CLASS A AVIATION MISHAP THAT OCCURRED ON 8 JUNE 2022 IN THE R-2512 RANGE COMPLEX

106. MCC3 was on the day maintenance shift schedule for 6-7 June 2022 and ended his day maintenance shift on the afternoon of 7 June 2022. [Encl (28-30)]

107. There were no indications that MCC3 was involved in maintenance or other duties that caused him to work late or remain at the squadron in a manner that violated required crew rest on the evening of 7 June 2022. [Encl (24, 28-30)]

Mishap Timeline of Events

108. On 7 June 2022 the Commanding Officer of VMM-364 approved the squadron's flight schedule and signed the Risk Assessment Worksheets (RAW) for each flight event for 8 June 2022, all of which had been screened and signed by the appropriate supervisors and reviewers. [Encl (16, 55)]

109. One of the flight events approved on the 8 June 2022 flight schedule was the MS comprised of MC1 and MC2. [Encl (16)]

110. The approved mission of the MS was to conduct Tactical Formation Maneuvers (TACFORM), day LAT in support of a LATI event, RVLs, and TG with the RMWS for a total of 4 sorties and 5.0 flight hours on each aircraft. [Encl (16)]

111. MC1 was comprised of MP1 who was performing duties as designated Section Leader and TAC, MP2 who was the aircraft T2P, MCC1 who was the Basic Instructor Crew Chief (BICC) and LATI, MCC2 who was a LATI under instruction, and MCC3 who was receiving LAT and CALs instruction. [Encl (16)]

112. Mishap Crew 2 (MC2) was comprised of Mishap Pilot 3 (MP3) who was the TAC and SLUI, Mishap Pilot 4 (MP4) who was the T2P, Mishap Crew Chief 4 (MCC4) who was the LATI and Weapons and Tactics Instructor (WTI), Mishap Crew Chief 5 (MCC5) who was a LATI under instruction, and Mishap Crew Chief 6 (MCC6) who was receiving TACFORM and CALs instruction. [Encl (16)]

113. MC1 and MC2 were afforded the appropriate crew rest for a period of no less than eight hours the night before the mishap. [Encl (15-16, 26-30)]

114. The MA1 and MA2 were certified as safe for flight the evening prior to the flight on 7 June 2022. [Encl (17, 24-25)]

115. Both MA1 and MA2 were identified as partial mission capable due to inoperable EAPS. [Encl (17-18, 24-30)]

116. MP3 was to perform duties as the TAC for MA2 and SLUI and was to be evaluated by MP1 from MA1. [Encl (26-30)]

Subj: COMMAND INVESTIGATION INTO THE CLASS A AVIATION MISHAP THAT OCCURRED ON 8 JUNE 2022 IN THE R-2512 RANGE COMPLEX

117. To facilitate SLUI training for MP3, MC1 and MC2 planned to swap lead and wingman positions and responsibilities. As the designated Section Leader, MP1 was expected to closely monitor and provide guidance as necessary to MP3 in the performance of SLUI duties. [Encl (26-30)]

118. At 0600 on 8 June 2022, in accordance with the flight schedule, the Operations Duty Officer (ODO) conducted a brief for the MS that covered the weather forecasted for the mission areas of operation, applicable Notices to Airmen (NOTAMs), bird aircraft strike hazard (BASH) conditions, and operating area special instructions (SPINS). [Encl (16, 26-30, 46, 57)]

119. There were no NOTAMs affecting the R-2512 Restricted Area. [Encl (26-28, 46)]

120. During the weather portion of the ODO brief, the MS determined that low clouds and reduced visibility at Marine Corps Air Station (MCAS) Camp Pendleton would not permit the MS to launch as a section and that an Instrument Flight Rules (IFR) departure as single aircraft was required in order to depart the airfield. The weather at the subsequent destinations further east was suitable, and once clear of the low ceilings at Camp Pendleton, the section could proceed per plan. [Encl (26-30, 46, 59)]

121. Immediately following the ODO brief, the MP3 conducted the mission flight brief for the MS as the SLUI, at the completion of which MC1 and MC2 conducted separate NATOPS flight briefs. [Encl (26-30)]

122. Due to inoperable EAPS on both MA1 and MA2, the MS was unable to conduct RVLs per the flight schedule, so they changed their plan to conduct CALs to an improved, paved surface at LZ Rice. This was a modification to the scheduled mission and within the Section Leader's authority to adjust based on mission execution parameters. [Encl (16, 25-30)]

123. MP1, as the TAC and Section Leader responsible for flight mission execution, signed the RAW after appropriate mission and crew briefs prior to the flight conducted on 8 June 2022. Mitigated risk level was deemed to be negligible. [Encl (55)]

124. MP1 and MP3 certified and signed for their respective aircraft and proceeded to execute the mission as modified with identified discrepancies. [Encl (24-25)]

125. Delayed by the change in plan and subsequent requirement to file an IFR flight plan with Air Traffic Control (ATC), MA2 launched at 0834, and MA1 launched at 0840. [Encl (26-30, 46, 57)]

126. After departure, MA1 and MA2 effected a join up and executed the TACFORM, LAT, and CALs portions of the mission. During the CALs portion of the mission, MP1 made a radio call to MP3 to request transitioning from CONV CALs to APLN CALs due to climbing gearbox temperatures. The section transitioned to APLN CALs and completed remaining CAL training requirements without incident or additional reports of increasing gearbox temperatures from MA1. [Encl (26-30)]

Subj: COMMAND INVESTIGATION INTO THE CLASS A AVIATION MISHAP THAT OCCURRED ON 8 JUNE 2022 IN THE R-2512 RANGE COMPLEX

127. No RVLs were conducted by the MS on 8 June 2022. [Encl (26-30)]

128. At 1150, on completion of hot-refuel operations at Lake Havasu City Municipal Airport, the MS proceeded to the R-2512 Range Complex. The MS entered a holding pattern approximately 7 miles east of R-2512 to coordinate range entry with the controlling agency, Yuma Range. [Encl (26-27)]



Figure 3

129. R-2512 is a special use airspace or restricted area that contains two areas designated for aerial gunnery training with designated altitudes from the surface to 23,000 feet, and the following boundaries: Beginning at lat. 33°05'00"N., long. 115°17'33"W.; to lat. 33°00'00"N., long. 115°13'33"W.; to lat. 32°51'00"N., long. 115°05'33"W.; to lat. 32°51'00"N., long. 115°17'03"W.; to lat. 32°58'00"N., long. 115°17'33"W.; to lat. 33°05'00"N., long. 115°20'03"W.; to the point of beginning (Figure 3). [Ref (p), Encl (45, 50, 52, 56)]

130. At 1201, after coordination with Yuma Range and switching to the Inky Barley discrete range frequency, the MS entered R-2512 from the east on a westerly heading. [Encl (26-30, 61)]

131. The MS conducted a range clearing pass from east to west from 1201 to 1203:15 and reported to Range Control that the Inky Barley range was clear of obstacles or interlopers. Range Control authorized the MS to conduct live fire operations, and to keep all fires and effects of fires to the south of the target area. [Encl (26-30, 61-64)]

132. In accordance with the mission brief, the MS was flying a “dog-bone” weapons employment pattern (Figure 4). [Ref (f), Encl (26-30, 45, 61-64)]

Subj: COMMAND INVESTIGATION INTO THE CLASS A AVIATION MISHAP THAT OCCURRED ON 8 JUNE 2022 IN THE R-2512 RANGE COMPLEX

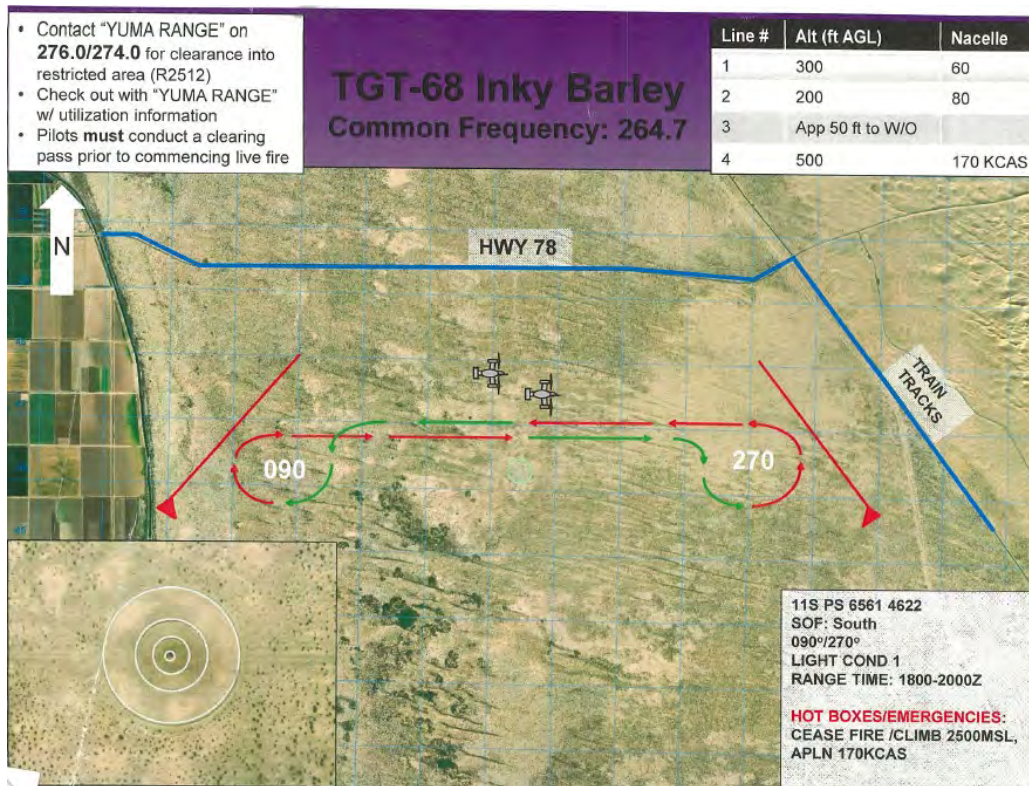

Figure 4

133. The MS aircraft configuration for Line 2 TG profiles was 200' above ground level (AGL), landing gear retracted, and nacelles set to 80 degrees resulting in approximately 80 knots of airspeed. Line 2 is the only TG profile that was planned to be used by the MS during operations within the R-2512 Range Complex and can be seen in the top right portion of the MS briefing graphic above (Figure 4) as one of four available profiles. [Encl (26-30, 45, 61-64)]

134. To maximize efficiency during dog-bone RMWS ordnance employment, MA1, in the wingman position, would fly in a Combat Cruise position to the aft and north of MA2. This formation allowed both aircraft to fire on the Inky Barley target simultaneously, while ensuring lateral and altitude deconfliction of fires, mitigating the risk of fratricide and abiding by the range requirements to keep all fires and effects of fires oriented south. [Ref (f), Encl (26-30, 45, 61-64)]

135. According to radar analysis of the flight, position data downloaded from MA2's Data Transfer Module, and MA2 interview statements, the MS was between approximately 200' and 270' AGL while conducting operations in the Inky Barley target area of the R-2512 range Complex. [Encl (26-30, 45, 61-64)]

136. The formation flown by the MS was Combat Cruise, which required MA1 (in the wing position) to maintain approximately 1,500 ft/0.3 nautical mile (nm) Tactical Aid to Navigation (TACAN) Distance Measuring Equipment (DME) to 1.0nm DME of separation, and 25' of step-

Subj: COMMAND INVESTIGATION INTO THE CLASS A AVIATION MISHAP THAT OCCURRED ON 8 JUNE 2022 IN THE R-2512 RANGE COMPLEX

up (50-75' of step-up during crossovers) to avoid the wake turbulence of the lead aircraft. [Ref (c, e, f), Encl (26-30, 45, 61-64)]

137. Radar analysis and MC2 statements indicate that MA1 maintained appropriate Combat Cruise position during operations in the Inky Barley target area of range R-2512. [Encl (26-30, 61, 63-64)]

138. From 1204-1206 following the range clearing pass, the MS conducted the first live fire TG pass on an eastbound heading with ordnance fired on a southerly heading, per range regulations. [Encl (26-30, 61-64)]

139. From 1206 to 1207:30 on the completion of the eastbound ordnance delivery leg, the MS conducted a reversal turn in accordance with the planned dog-bone pattern for approximately 240 degrees of azimuth change at approximately 30-degree angle of bank to reset for a westbound second ordnance delivery leg. [Encl (26-30, 61-64)]

140. At 1207:30 the MS conducted their second ordnance delivery leg on a westbound heading of 270 degrees magnetic for 1 minute and 30 seconds. [Encl (26-30, 61-64)]

141. From 1209 to 1210:30 on completion of the westbound ordnance leg, the MS entered the western end of the dog-bone pattern and conducted a reversal turn through 240 degrees of heading change at approximately 30-degree angle of bank to reset for a third ordnance delivery leg. [Encl (26-30, 61-64)]

142. The MS conducted the third ordnance delivery leg on an easterly heading from 1210:30 to 1212. [Encl (26-30, 61-64)]

143. At 1212 the MS entered the eastern portion of the dog-bone pattern to conduct a reversal to a westerly heading for a fourth ordnance delivery leg. On the initial portion of the dog-bone pattern, MC1 (wing position) informed MC2 (lead position) on the MS intra-flight radio frequency that MA1 had indications of "hot boxes." In accordance with the briefed hot gearbox plan, MA1 would transition to APLN and climb into the overhead pattern of 2500MSL. [Encl (26-30, 45, 61-64)]

144. At 1213 MC2 acknowledged and approved MC1's request to enter the overhead pattern. The approval was acknowledged by MC1, who positioned MA1 for a crossover from Combat Cruise wingman position to gain separation from MA2 and climb into the overhead pattern. [Encl (26-30, 61-64)]

145. From 1212 to 1214, MCC4 and MCC5 were conducting preparation for the fourth ordnance delivery leg. [Encl (26-30, 61-64)]

146. At 1214 MCC4 saw MA1 conduct a left to right crossover through MA2's longitudinal axis while MA2 was leading the MS through the northbound turn portion of the eastern end of the dog-bone pattern. MA2 was in a left hand (LH) 30-degree angle of bank with a heading of 295

Subj: COMMAND INVESTIGATION INTO THE CLASS A AVIATION MISHAP THAT OCCURRED ON 8 JUNE 2022 IN THE R-2512 RANGE COMPLEX

degrees magnetic when MA1 began to climb for entry into the overhead pattern.
[Encl (26-30, 61-64)]

147. MCC4, MCC5, and MCC6 did not witness abnormalities in MA1's flight path or attitude during the set up and execution of the crossover. [Encl (28-30)]

148. MCC5 and MCC6 were not able to consistently observe MA1 but noted that MA1 held Combat Cruise position correctly during TG operations in the R-2512. [Encl (28-30)]

149. At 1214 as MA1 began to increase altitude, MCC4 lost visual contact with MA1 due to MA2 angle of bank and obscured portions of the field of view caused by MA2 fuselage, horizontal elevators and vertical stabilizers. [Encl (28-30, 61-64)]

150. Last valid radar contact from the El Centro Airport Surveillance Radar (ASR) for MA1 was 1214:07, at an altitude of 500' MSL on a heading of 295 degrees magnetic and 95 knots airspeed. [Encl (63, 64,

151.

152.

153.

154.

155.

156.

157.

158.

159.

160.

Subj: COMMAND INVESTIGATION INTO THE CLASS A AVIATION MISHAP THAT OCCURRED ON 8 JUNE 2022 IN THE R-2512 RANGE COMPLEX

161. The time of MA1 ground impact was 1214:18. [Encl (61, 63-64)]

162. MC1 made no radio communications to MC2 or outside agencies prior to ground impact. [Encl (26-30)]

163. There are no direct witnesses of the mishap. [Encl (26-30, 72-75)]

164. There is no evidence that weather or sun angle contributed to the mishap. The sky was clear with light winds and the sun was approximately 60 degrees above the horizon during the MS RMWS/TG window. [Encl (26-30, 46, 58-60, 72-75)]

165. There is no evidence of a MC2 RMWS negligent discharge, or ordnance cook-off that could have impacted MA1 and resulted in fratricide. [Encl (26-30, 61-66,

166. All individuals associated with the mishap stated that there were no other aircraft, personnel, or birds within the R-2512 Range Complex other than the MS. [Encl (26-30, 46, 61, 72-75)]

Post - Mishap Events

167. At 1215, believing that MA1 had entered the 2500ft MSL overhead pattern to cool hot gearboxes, MC2 conducted a westbound live fire ordnance leg that took 1 minute and 30 seconds to complete. [Encl (26-30, 61-64)]

168. MC1 did not report to MC2 as established in the overhead pattern or provide further communication. [Encl (26-30)]

169. On completion of the MA2 westbound live fire ordnance leg at 1215:30, MCC4, MCC5, and MCC6 observed a column of smoke to the east of MA2's position but lost contact with it as MA2 turned to enter the western end of the dog-bone pattern reversal for an eastbound live fire ordnance leg. [Encl (26-30, 61-64)]

170. At 1217 MA2 rolled out on an easterly heading and MP3 and MP4 saw a tall column of black smoke within the R-2512 Range Complex boundary. After discussing possible sources of the smoke, MC2 made a radio call to MC1 for a status update. [Encl (26-30, 61, 63-64)]

171. At 1218:30 MC2 recognized that the column of smoke was from MA1 and notified Yuma Range Control. [Encl (26-30, 61, 63-64)]

172. MA2 flew close the crash site at approximately 200-300' AGL to look for survivors from MA1. [Encl (26-30, 61, 63-64)]

173. MC2 assessed there to be no survivors based on observation of the MA1 crash site. [Encl (26-30, 65, 66, 72-75)]

Subj: COMMAND INVESTIGATION INTO THE CLASS A AVIATION MISHAP THAT OCCURRED ON 8 JUNE 2022 IN THE R-2512 RANGE COMPLEX

174. MC2 determined they were unable to land due to an inoperable EAPS on the RH nacelle which prohibited RVLs. [Encl (17, 26-30)]

175. At 1219 MP3 assumed the duties of On-Scene Commander (OSC), climbed MA2 to approximately 3000' AGL to increase line of sight radio communication with Yuma Range Control, changed the Mode 3A transponder to emergency code 7700, and requested additional aircraft and first responder resources to assist search and rescue efforts for MC1. [Encl (26-30, 61, 63-64)]

176. At 1225 Yuma Range Control contacted Wolfpack 11, a section of two CH-53Es conducting ordnance training in the Mt. Barrow portion of the R-2507S Yuma Range Complex nearby to request assistance with MA2 and the MA1 crash site. [Encl (26-30, 69-76)]

177. At 1245 Yuma Range Control requested assistance from Landslide 05, a single MH-60S conducting training within the local area. [Encl (26-30, 69-75, 77)]

178. At 1246 Wolfpack 11 arrived from the eastern side of the R-2512 range complex, made radio contact with MA2, and circled the MA1 crash site in preparation to land. [Encl (26-30, 69-75)]

179. At 1250 Landslide 05 contacted MA2 and began search and rescue flight patterns in vicinity of the crash site to search for survivors and additional aircraft wreckage. [Encl (26-30, 69-75)]

180. At 1253 Wolfpack 11 landed approximately 200 meters (m) southeast of the crash site and disembarked two Crew Chiefs per aircraft and an additional pilot embarked as special crew from Wolfpack 12 with handheld fire extinguishers to search for survivors and fight the fire, which had dissipated such that the personnel were able to approach the MA1 wreckage. [Encl (26-30, 69-75)]

181. From 1255 to 1310 the Wolfpack 11 and 12 disembarked personnel expended handheld fire extinguishers on what appeared to be the cockpit portion of the wreckage and returned to their respective aircraft after a thorough, 360-degree search of the wreckage for survivors. During the search, Wolfpack disembarked personnel discovered the remains of four of the five members of MC1. [Encl (26-30, 69-75)]

182. At 1305 MA2 reached their "Bingo" or minimum fuel required for the return flight to home station, transitioned OSC duties to Landslide 05 and departed the overhead pattern to return to MCAS Camp Pendleton. [Encl (26-30, 69-75)]

183. At 1310 Wolfpack 11 reported their observations to MA2, Landslide 05, and Yuma Range Control, and departed the crash site to return to Marine Corps Air Station Miramar. [Encl (70-75)]

184. At 1324 Landslide 05 coordinated with Landslide 20 to take over OSC duties if Landslide 05 required fuel before first responder personnel arrived. [Encl (70, 75)]

Subj: COMMAND INVESTIGATION INTO THE CLASS A AVIATION MISHAP THAT OCCURRED ON 8 JUNE 2022 IN THE R-2512 RANGE COMPLEX

185. At 1325 Landslide 05 contacted a local helicopter medical evacuation service for support in the event one of the MA1 aircrew survived the crash, but later cancelled the request due to the assessment that there were no MC1 survivors. [Encl (70, 75)]

186. From 1325 to 1345 Landslide 05 conducted several landings to coordinate and guide first responder personnel to the crash site. The arrival of first responder personnel was delayed by the remote location of the crash site and lack of roads or paved surfaces. [Encl (70, 75)]

187. At 1345 Imperial County First Responders arrived at the crash site but had to request approval from local Federal Firefighters prior to entering the crash site area due to the hazard posed by MA1 unexpended ordnance. [Encl (70, 75)]

188. At 1348 Imperial County First Responders received approval to enter the crash site area to begin firefighting efforts. [Encl (70, 75)]

189. From 1411 to 1510 Imperial County and Naval Air Facility (NAF) El Centro Federal Firefighters were supported by Landslide 05 and 20. [Encl (70, 75, 77)]

190. At 1510 Landslide 20 transitioned OSC duties to NAF El Centro Federal Firefighters and returned to NAF El Centro. [Encl (70, 75)]

191. At 1800 the MA1 fire had subsided to a point that enabled first responder personnel to discover the remains of MCC3. [Encl (75)]

Relevant Procedures and Evidence

192. Aircrew involved or associated with the mishap stated that all communications equipment was available and functioned properly. [Encl (17-18, 25-30)]

193. MC1 and MC2 did not identify sociological, psychological, or other human factors that reasonably could have caused or contributed to the cause of the mishap; no additional evidence was identified throughout the investigation that indicated that potential stress factors, fatigue, use of medication, or prohibited substances contributed to or caused the mishap. [Encl (16, 23-24, 26-30, 55)]

194.

195. The MV-22B NATOPS defines “Land immediately” as executing a landing without delay. Continued operation of the aircraft is extremely hazardous. If over water, conduct a controlled ditching without delay. The primary consideration is to assure the survival of occupants. [Ref (c)]

Subj: COMMAND INVESTIGATION INTO THE CLASS A AVIATION MISHAP THAT OCCURRED ON 8 JUNE 2022 IN THE R-2512 RANGE COMPLEX

196. The MV-22B NATOPS defines “Land as soon as possible” as executing a landing at the nearest available site which a safe landing can be made. [Ref (c)]

197. The MV-22B NATOPS uses “Land as soon as practical” to mean that extended flight is not recommended. The landing site and duration of flight is at the discretion of the pilot-in-command. [Ref (c)]

198. The term “hot box” refers to the temperature of the oil in any of the MV-22B gearboxes (MWGB, TAGB, and PRGB). Typically, when aircrew communicate that they have “hot boxes,” at least one of their gearboxes is either approaching or has entered the “High Caution” range as defined in Figure 5. [Ref (c, d)]

OIL TEMPERATURE	
MWGB BOTH ENGINES OPERATING/SINGLE ENGINE/PRGB/TAGB BOTH ENGINES OPERATING	
>132 °C	HIGH WARNING
>110 to 132 °C	HIGH CAUTION
20 to 110 °C	NORMAL
<20 °C	LOW CAUTION
PRGB/TAGB SINGLE ENGINE	
>121 °C	HIGH WARNING
>110 to 121 °C	HIGH CAUTION
20 to 110 °C	NORMAL
<20 °C	LOW CAUTION

Figure 5

199. Once gearbox temperature enters the High Caution range, corrective action must be taken per the emergency procedures in the MV-22B NATOPS. The decision to take preemptive cooling actions is at the discretion of the aircraft commander. [Ref (c, d)]

200. MV-22B gearbox heat mitigation procedures increase airflow through the engines and gearboxes by transitioning to APLN, which places engine and gearbox air intakes into the relative wind/direction of travel, thereby greatly increasing airflow and drivetrain component cooling. [Ref (c, d)]

201. MV-22B severe gearbox temperature emergencies require the aircraft to “Land as soon as possible.” This requirement allows the aircrew time to find the nearest safe landing site in which a Precautionary Emergency Landing (PEL) can be made. [Ref (c, d)]

202.

Subj: COMMAND INVESTIGATION INTO THE CLASS A AVIATION MISHAP THAT OCCURRED ON 8 JUNE 2022 IN THE R-2512 RANGE COMPLEX

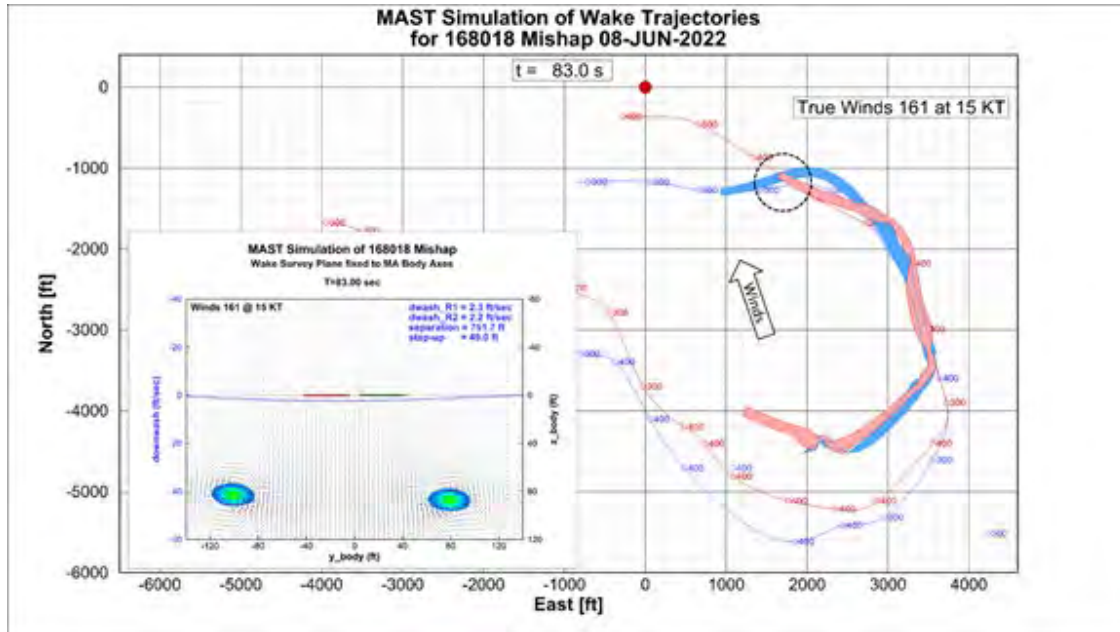

Figure 6

203. A HCE is a V-22 aircraft emergency that results in a momentary input quill clutch slippage (between the engine and PRGB). When the clutch reengages, the HCE occurs. A HCE can result in severe damage to drive system components including engine over-torque, PRGB over-torque, shaft driven compressor failure, nacelle blower failure, and damage to the engine TM shaft. Indications of TM shaft damage may include poor rotor governor management with associated Nr (proprotor revolutions per minute expressed as a percentage) decay at high power demand. A further complicating factor of a HCE is that a HCE on one side can ultimately initiate a HCE on the opposing side. [Ref (c)]

204. TM shaft damage due to HCE may result in permanent reduction of power available from one or both engines. [Ref (c)]

205. In severe HCE events, the TM shaft may deform or shear. Shearing of the TM shaft will result in engine over-speed and shutdown as commanded by the FADEC. If this were to occur, torque would rapidly be transferred back to the initiating side. This rapid torque reversal can deform or shear the TM on the initiating side resulting in reduced power available or, if the initiating TM shears, a dual engine failure. [Ref (c)]

206. High power settings following a HCE may cause further engine surge or Nr decay and increased descent rate. In severe cases, Nr may not be recoverable. [Ref (c)]

207. Air Force Special Operations Command (AFSOC) grounded its CV-22 Osprey fleet on 16 August 2022 as part of a safety stand down for incidents of HCE and cleared its CV-22s for flight on 2 September 2022. [Encl (79)]

208.

Subj: COMMAND INVESTIGATION INTO THE CLASS A AVIATION MISHAP THAT OCCURRED ON 8 JUNE 2022 IN THE R-2512 RANGE COMPLEX

209.

210.

211.

212. The failure of an MV-22B engine in combination with an ICDS failure creates an asymmetric power condition that requires immediate response to regain control. The failure will cut off power to one side's proprotors, creating a thrust asymmetry as the functioning engine can only drive a single set of proprotors. [Ref (c)]

213. A warning from the MV-22B ICDS Failure Emergency procedure states that "single engine with an ICDS failure is unrecoverable below 170-175 Knots Calibrated Airspeed (KCAS)." [Ref (c)]

214. The MA1 crash site indicates a high angle impact with a magnetic heading of approximately 150 degrees. [Encl (65-)]

215. Radar analysis and MC2 statements indicate MA1's last reported direction of flight as approximately 295 degrees magnetic and climbing. [Encl (61-

216. The position of the MA1 conversion actuators indicates a nacelle position of 86 degrees. [Encl (65)]

217. MA1 EI and crash site analysis indicates the position of MA1 landing gear to be in the retracted or up position. [Encl (65-)]

218. MA1 EI indicates elevator actuators deflected full trail edge up, and cockpit control feel drive actuator in the "less than 50 knot airspeed" configuration. [Encl 65-

219. The MA1 crash site wreckage is contained within a radius of approximately 75m from the center point of the wreckage. [Encl (65-)]

Subj: COMMAND INVESTIGATION INTO THE CLASS A AVIATION MISHAP THAT OCCURRED ON 8 JUNE 2022 IN THE R-2512 RANGE COMPLEX

220. The soil composition in and around the MA1 crash site is soft, deep sand with sparse vegetation, relatively level grade, and mildly undulating terrain. [Encl (66-)]

221. There are six impact craters identified at the MA1 crash site. The largest, impact crater #1, is along the longitudinal axis of MA1 wreckage. Impact crater #2 is just forward of the wing on the MA1 longitudinal axis. Impact crater #3 is on the left side of the longitudinal axis of MA1 wreckage and forward of the wing. Impact crater #4 on the right side of the longitudinal axis of the MA1 wreckage and forward of the cockpit area. Impact crater #5 is aft of the wing area on the right side of the longitudinal axis of the MA1 wreckage. Impact crater #6 is on the right side of the longitudinal axis, aft of impact crater #5 and MA1 wreckage. [Encl (65-67)]

222. Impact crater #1 is aligned with MA1 fuselage orientation of 150 degrees magnetic, is roughly six feet wide and is located near the tail section of the MA1 wreckage. [Encl (65-67)]

223. The investigative team measured the width of the MV-22 ramp as five feet, 11.25 inches. [Ref (c), Encl (65-67)]

224. The tail section of MA1, from the elevators to behind the wing root, was discovered inverted, broken away from the fuselage, and rotated approximately 70 degrees left of the longitudinal axis of MA1 wreckage. [Encl (65-67)]

225. The MA1 upper ramp door was located close to the tail and ramp section on the left of the MA1 longitudinal axis. [Encl (65-67)]

226. The MA1 RMWS GAU-21, weapons cradle, ramp mount, and associated components were discovered forward of the wing area on the left of the MA1 longitudinal axis. [Encl (65-67)]

227. The LH nacelle and PRGB were found forward of the wing; the LH Engine was separated from the nacelle and was also forward of the left wing. Both components were in close proximity to each other and displayed mild evidence of fire damage. [Encl (65-67)]

228. The LH proprotors sheared with indication of “broom-strawing” (material fragmentation designed to reduce impact energy of proprotors) from the proprotor hub and were aligned along an axis on the left, parallel to the MA1 wreckage longitudinal axis. [Encl (65-67)]

229. The RH nacelle, PRGB and engine remained intact as an assembly, had little damage from the post-crash fire, and were to the aft and right of MA1 longitudinal axis. The proprotors were damaged but mostly intact; they remained attached to the proprotor hub. [Encl (65-67)]

230. The MA1 RH vertical stabilizer was found aft and left of the fuselage longitudinal axis; it was intact and had no evidence of fire damage. [Encl (65-67)]

231. The cockpit area of MA1 was found forward of the wing in impact crater #2 and along the longitudinal axis. The aerial re-fueling probe was buried almost entirely in the sand forward of the cockpit area. [Encl (65-67)]

Subj: COMMAND INVESTIGATION INTO THE CLASS A AVIATION MISHAP THAT OCCURRED ON 8 JUNE 2022 IN THE R-2512 RANGE COMPLEX

232. A portion of the compressor section from MA1's LH Engine was found 50m to the north of the MA1 wreckage. [Encl (65-67)]

233. The MA1 Ground Refueling Display Panel was found intact with no other associated components approximately 60m from the rear of the MA1 wreckage on an axis perpendicular to the MA1 longitudinal axis. [Encl (65-67)]

234. The remains of all MC1 were discovered in their respective crew positions. [Encl (65-67, 72-75)]

235. MA1 safety equipment was available, in proper condition and worn or installed appropriately. [Encl (17, 18, 24-28, 65-67)]

236. The components of both seat support frames of MP1 and MP2 were found with Variable Load Energy Absorbers (VLEAs) intact. The weight settings for the VLEAs could not be determined due to thermal damage. [Encl 67]

237. The seat support structures for MP1 and MP2 were found detached from their mounting points on the MA1 cockpit bulkhead. [Encl 67]

238. The seats of MP1 and MP2 did not absorb energy in the vertical direction relative to the seats. The seats are designed to compress or "stroke" to absorb impact energy at roughly 14 Gs of vertical impact. Off axis loading or failure of the seat support structure caused the seats not to stroke. In accordance with specifications, the seats of MP1 and MP2 (to include the entire seat assembly and attachment points on the bulkhead) were certified to provide restraint at 32 Gs of longitudinal acceleration and withstand a vertical acceleration of 50 Gs with a 230-pound occupant. [Encl 67]

239. Analysis of the crash site revealed no attempts to use cartridge or propellant activated devices to egress MA1 after ground impact. [Encl 67]

240. A historical analysis of 614 V-22 Class A through C mishaps and hazard reports from March 2010 to August 2022 discovered 15 HCE events have occurred within the 680,000 flight hours logged by USAF and USMC V-22s. Of the 15 HCE events, 10 have occurred within the first 3 seconds of vertical takeoff. [Encl , 80-81)]

241. On February 3, 2023, the Joint Program Management Activity 275 released Dynamic Component Bulletin 63 for MV-22s that grounded aircraft with input quills flown for more than 800 hours. Although the root cause of HCE remains unknown, incident trend analysis shows that HCE events have occurred in aircraft with input quills flown more than 800 hours. Dynamic Component Bulletin 63 is intended to reduce incidents of HCE across the fleet while the root cause analysis of HCE continues. [Ref (q)]

Damages and Costs

Subj: COMMAND INVESTIGATION INTO THE CLASS A AVIATION MISHAP THAT OCCURRED ON 8 JUNE 2022 IN THE R-2512 RANGE COMPLEX

242. As of the completion of this investigation, there is no change to the line of duty determination of the Preliminary Inquiries for MC1. [Encl (10-14, 83)]

243. Although no injuries occurred, the Wolfpack 11 section and Landslide 05 aircrew that likely ingested fumes while searching the MA1 crash site for survivors should have the event documented appropriately in their medical records. [Encl (70-77, 83)]

244.

Opinions

1. The mishap was not caused by human factors or a lack of preparation. Pilot and Aircrew preparation was appropriate and in accordance with regulations. There were no human factors or evidence that would suggest an inability to meet mission requirements by any of the pilots or aircrew involved in the mishap. Mission briefing and pre-flight requirements were met by all members of the MS. [FF (44-165, 192)]

2. The mishap was not caused by factors external to the flight. Weather, winds, and solar position were ideal for conducting TG operations. There were no interlopers or birds within the R-2512 Range Complex at the time of the mishap. The R-2512 Range Complex was not affected by NOTAMs and there were no additional mission requirements placed on the crew that may have distracted the pilots or aircrew during TG operations. [FF 107-165]

3. The mishap was not caused by maintenance malpractice or deviation from established component specifications or inspection criteria. [FF 33-42]

4. The mishap was caused by a dual HCE event that created a Single Engine/ICDS failure compound emergency leading to an unrecoverable low altitude departure from controlled flight and rapid rate of descent. While on climb-out to an overhead pattern on an approximate heading of 295 degrees, MA1 experienced a dual HCE that sent destructive impulses throughout the drivetrain. The dual HCE caused the RH TM shaft to shear and the LH TM shaft to yield, resulting in a RH Engine over-speed and a LH Engine power limited condition. In response to the RH engine over-speed the RH FADEC executed a controlled engine shutdown causing a rapid engagement of the ICDS to allow the LH engine to power the RH propotor. The rapid transfer of torque sent destructive impulses through the drivetrain causing the MA1 ICDS to fail. The MA1 ICDS failure led to a complete loss of RH propotor thrust. The sudden loss of thrust from the RH propotor triggered an extreme thrust asymmetry and departure from controlled flight. MP1 and MP2 fought to regain control of MA1 in the rapid and uncontrolled turning descent, rolling the nacelles six degrees aft to 86 degrees to increase the vertical component of the MA1 lift vector. The MA1 aircrew remained in their crew positions to work through the emergency condition but the departure from controlled flight was unrecoverable based on MA1 configuration and altitude. There were no prior indications of an impending dual HCE event, no steps that MP1 or MP2 could have taken to prevent its occurrence, and no means of recovery once the compound emergency commenced. The force of MA1 ground impact exceeded the

Subj: COMMAND INVESTIGATION INTO THE CLASS A AVIATION MISHAP THAT OCCURRED ON 8 JUNE 2022 IN THE R-2512 RANGE COMPLEX

ability of MC1 to survive or egress the aircraft prior to the subsequent post-crash fire that consumed the aircraft. [FF (1-9, 11-16, 130-165, 201-205, 211-220, 226)]

5. Crash site analysis, indirect witness statements from MA2, the EI from FRC-E, radar analysis of the MS flight path, and flight path reconstruction from ASIST indicate a rapid, uncontrolled turning descent by MA1. The entirety of MA1 wreckage is within a diameter of approximately 150m indicating a high angle, near vertical impact. On ground impact MA1 nacelle angles were 86 degrees, landing gear up, elevator actuators deflected full trail edge up, and cockpit control feel drive actuator in the “less than 50 knot airspeed” configuration. Crash site and EI analysis indicates MA1 impacted the ground with a steep, right wing down attitude. The slight right wing down attitude of MA1 on impact caused the RH and LH nacelles to depart the wings and the aft section of the fuselage to shear at the wing root, pitching vertically in a twisting motion and landing inverted on the left side of MA1. The off-axis impact caused the seats of MP1 and MP2 to detach from their mounts, negating the ability of the seats to absorb impact energy. The force of the impact separated the cockpit from the fuselage and caused the fuel cells to rupture leading to an instantaneous post-crash fire. [FF (1-9, 11-16, 130-165, 201-205, 211-220, 226)]

6. Prior to the tragic events of 8 June 2022, a Single Engine/ICDS failure resulting from a dual HCE event had not been experienced in the V-22 community. The ICDS of MA1 was maintained correctly and was within component life limits but was not capable of withstanding the forces generated by the dual HCE event. The V-22 ICDS must be examined to validate design specifications and material strength and component life limits, ensuring all drivetrain components can withstand the extreme forces caused by dual HCE events. [FF (1-3, 115, 122, 127-132, 154, 155, 166-169, 172-175, 186-195)]

7. Within the last 10 years, the safety record of the MV-22B is consistent with that of other tactical aircraft within the DoD inventory. The mishap of 8 June 2022 does not statistically invalidate the safety of the platform within the broader context of over 422,000 successful MV-22B and CMV-22B flight hours flown in the past 10 years. However, the root cause of HCE remains unknown. Future incidents of V-22 ICDS failure from a dual HCE event are impossible to prevent without improvements to flight control system software, drivetrain component material strength, and robust inspection requirements. [FF (1-3, 115, 122, 127-132, 154, 155, 166-169, 172-175, 186-195)]

Recommendations

1. No further investigation is required.
2. No disciplinary action against any Marine or unit is warranted by this mishap.
3. No administrative action against any Marine or unit is warranted by this mishap.
4. Recommend an immediate one-time inspection of MV-22B ICDS to ensure compliance with design, component life, and material specifications.

Subj: COMMAND INVESTIGATION INTO THE CLASS A AVIATION MISHAP THAT OCCURRED ON 8 JUNE 2022 IN THE R-2512 RANGE COMPLEX

5. Recommend PMA 275, in coordination with the original equipment manufacturer continue HCE Integrated Product Team investigative efforts to determine the root cause of HCE events.

6. Recommend PMA 275, in coordination with the original equipment manufacturer design and field a new Proprotor Gearbox Input Quill Assembly that mitigates unintentional clutch disengagements and HCE events.

7. Recommend PMA 275, in coordination with the original equipment manufacturer improve MV-22B drivetrain and flight control system software, drivetrain component material strength, and inspection requirements.

8. Recommend PMA 275, in coordination with the original equipment manufacturer, integrate a crash survivable, high-temperature, fire-resistant flight data recorder into all MV-22B aircraft.

9. Recommend USMC MV-22B commands brief this mishap to pilots and aircrew to discuss the hazards of HCE and its potential to cause a Single Engine/ICDS failure compound emergency.



UNITED STATES MARINE CORPS,

THIRD MARINE AIRCRAFT WING, FMF
MARINE CORPS AIR STATION MIRAMAR
P.O. BOX 452038
SAN DIEGO CA 92145-2038

IN REPLY REFER TO:
5830
OSJA
13 Jun 22

From: Commanding General, 3d Marine Aircraft Wing, FMF
To: USMC

Subj: COMMAND INVESTIGATION INTO THE CLASS A AVIATION MISHAP THAT
OCCURRED ON 08 JUNE 2022 IN THE R-2512 RANGE COMPLEX

Ref: (a) 10 U.S. Code, Section 2255
(b) JAGINST 5800.7G w/CH 1 (JAGMAN)

1. This Command Investigation (CI) is convened to investigate the circumstances surrounding a Class A aviation mishap in compliance with reference (a).
2. This letter appoints you in accordance with the references to investigate the cause and responsibility for the subject aviation mishap, the fatalities, description of all damage to property, and any attendant circumstances.
3. You are to complete both a line of duty determination Preliminary Inquiry (PI) and a Class A aviation mishap CI. Chapter II, Appendix A-2-k, and Appendix A-2-n of reference (b) are your governing reference materials. Templates for your PI and CI can be found at Appendix A-2-c and A-2-e, respectively.
 - a. You shall report your PI in writing by 14 calendar days from the date of this letter. If you require additional time, you shall submit a written request for such with detailed justification for any delay. Any request for extension shall be submitted via the 3d Marine Aircraft Wing's (3d MAW) Staff Judge Advocate (SJA). The request and associated response shall be included in your report.
 - b. You shall report your CI in writing by 60 calendar days from the date of this letter. If you require additional time, you shall submit a written request for such with detailed justification for the delay. Any request for extension shall be submitted via the 3d MAW SJA. The request and associated response shall be included in your report.
4. This is your primary duty until your PI and CI reports are completed, unless otherwise relieved of such duty by competent authority. Requests for additional support in your investigative efforts shall be submitted via the 3d MAW Chief of Staff. You are granted direct liaison authority with the senior member of the Aviation Mishap Board and with Naval Air Systems Command for requests related to this mishap.
5. You shall consult with the 3d MAW Director of Safety and Standardization and SJA on the conduct of your line of duty PI and aviation mishap CI.

Enclosure (1)

Subj: COMMAND INVESTIGATION INTO THE CLASS A AVIATION MISHAP THAT OCCURRED ON 08 JUNE 2022 IN THE R-2512 RANGE COMPLEX

6. By copy to: of this order, _____ are appointed as your assistant investigating officers, unless otherwise relieved of such duties by competent authority, to provide technical expertise on investigations.

7. The point of contact for this matter is the 3d MAW SJA, _____ at _____

Copy to:
CO, MAG-39
CO. VMM-364



UNITED STATES MARINE CORPS

THIRD MARINE AIRCRAFT WING, FMF
MARINE CORPS AIR STATION MIRAMAR
P.O. BOX 452038
SAN DIEGO CA 92145-2038

IN REPLY REFER TO:

5830

OSJA

5 Jul 22

From: Commanding General, 3d Marine Aircraft Wing, FMF
To: /8042 USMC

Subj: COMMAND INVESTIGATION INTO THE CLASS A AVIATION MISHAP THAT
OCCURRED ON 08 JUNE 2022 IN THE R-2512 RANGE COMPLEX

1. This is the first modification of the appointing order dated 13 June 2022. I hereby relieve
of duties attendant to this investigation and appoint
as an assistant investigating officer to provide technical expertise on investigations
2. All other aspects of the original appointing order remain in force.
3. The point of contact for this matter is the 3d MAW SJA, at

Copy to:
CO, MAG-39
CO, VMM-364
CO, VMM-165

Enclosure (2)



UNITED STATES MARINE CORPS

THIRD MARINE AIRCRAFT WING, FMF
MARINE CORPS AIR STATION MIRAMAR
P.O. BOX 452038
SAN DIEGO CA 92145-2038

IN REPLY REFER TO:
5830
OSJA
AUG 2 2022

From: Commanding General, 3d Marine Aircraft Wing, FMF
To: 8042 USMC

Subj: COMMAND INVESTIGATION INTO THE CLASS A AVIATION MISHAP THAT
OCCURRED ON 08 JUNE 2022 IN THE R-2512 RANGE COMPLEX

Ref: (a) Appointing Order dtd 13 June 2022
(b) First Modification to Appointing Order dtd 5 July 2022

1. This is the second modification of the appointing order dated 13 June 2022. I hereby relieve
of duties attendant to this investigation.
2. All other aspects of the original appointing order remain in force.
3. The point of contact for this matter is the 3d MAW SJA, at

Copy to:
CO, MAG-39
CO, VMM-364

Enclosure (3)

From:
To:
Subject: RE: VMM-364 CI Extension
Date: Friday, August 12, 2022 11:53:08 AM

Afternoon

I briefed the CG on the status of your investigation today and verbally approved your request for a 60 day extension. You can reference/include this email in the report to document the extension.

s/f

SJA, 3d MAW

-----Original Message-----

From:
Sent: Thursday, August 11, 2022 4:43 PM
To:
Subject: VMM-364 CI Extension

Do you need me to do anything for my VMM-364 CI extension letter?

Hope all is well.

SF.



UNITED STATES MARINE CORPS
3D MARINE AIRCRAFT WING, FMF
MARINE CORPS AIR STATION MIRAMAR
PO BOX 452038
SAN DIEGO CA 92145-2038

IN REPLY REFER TO
5830

CG
NOV 03 2022

FIRST ENDORSEMENT on ltr 5830 CI of 3 Oct 22

From: Commanding General, 3d Marine Aircraft Wing, FMF
To: Investigating Officer

Subj: COMMAND INVESTIGATION INTO THE CLASS A AVIATION MISHAP THAT
OCCURRED ON 8 JUNE 2022 IN THE R-2512 RANGE COMPLEX

1. Returned for further investigative action.
2. Prior to re-submitting this investigation, obtain all related engineering investigation reports related to the mishap aircraft system components. Incorporate any relevant information from those reports into the findings of fact, opinions, and recommendations of your report.
3. The point of contact for this matter is the 3d Marine Aircraft Wing Staff Judge Advocate,

Copy to:
File

Enclosure (4)

3RD MAW MISSION

The MAW HQ, as the senior Marine aviation command and control agency for the Marine Expeditionary Force (MEF), develops, directs and assesses air operations in the execution of the six functions of Marine aviation. The MAW HQ conducts force generation activities to provide aviation and aviation ground support units.

ABOUT

[Units](#)

[News](#)

[Photos](#)

[Leaders](#)

[Marines](#)

[Family](#)

[Community Relations](#)

Enclosure (5)



3RD MAW HISTORY



The 3rd Marine Aircraft Wing (3rd MAW) was commissioned on the 167th anniversary of the Marine Corps, November 10, 1942, at Marine Corps Air Station (MCAS) Cherry Point, North Carolina with a personnel roster of 13 officers, 25 enlisted men and one aircraft-a trainer.

The Wing's combat history began with the World War II deployment of a bomber squadron on December 3, 1943. A little more than a year later, the Wing deployed a night fighter squadron in support of the war effort.

On April 21, 1944, the Wing boarded three carriers for a voyage to Hawaii and arrived May 8, where it assumed the functions of Marine Air, Hawaii Area. When the Japanese

surrendered, 3rd MAW was decommissioned and its personnel were assigned to other units. The Wing had played an important, but behind-the-scenes, role in defeating the Japanese by giving the best training available to Marine pilots and support personnel.

In 1952, as the Corps again fought in the Far East, the Wing was reactivated at Cherry Point for the Korean War. The main portion of the Wing began moving to the new MCAS Miami, Florida- the Marine Corps' first "flying field."

In September 1955, the Wing left Miami for MCAS El Toro, California. 3d MAW was rebuilt again, with the addition of Marine Aircraft Groups (MAG) 15, followed by MAG-36 with its helicopter squadrons at a nearby Air Station in Santa Ana, California. Wing squadrons were detached and deployed to Vietnam as combat action in Southeast Asia flared. At the end of the Vietnam War several units were brought back to the United States and deactivated or re-designated, creating the 3rd MAW of today.

The Wing saw action again as part of I Marine Expeditionary Force (MEF), conducting operations in Iraq and Kuwait during Operation DESERT SHIELD, Operation DESERT STORM, and Operation SABER. After the end of hostilities, 3rd MAW aircraft provided support in Operations PROVIDE COMFORT and Operation SOUTHERN WATCH over Iraq. The Wing was once more called into service in Somalia for Operation RESTORE HOPE.

The fall of 2001 would reveal a new type of challenge, the Global War on Terror, and 3d MAW answered the call again by deploying units in support of Operation ENDURING FREEDOM both in Afghanistan and neighboring countries. Beginning in the fall of 2002, 3rd MAW deployed forces to Kuwait in preparation for combat operations in Iraq. 3rd MAW provided decisive aviation fires for I MEF and coalition forces in liberation of Iraq during Operation IRAQI FREEDON and subsequent

(Forward) Aviation Combat Element Headquarters at Camp Leatherneck, Regional Command Southwest, Afghanistan in 2010, 2012, and 2014, the latter of which planned and executed the withdrawal of Marine Aviation Forces from the Helmand Province and subsequent end to Operation ENDURING FREEDOM.

Today, the Marines and Sailors of 3rd MAW are deployed on land and sea conducting combat operations in support of Operation INHERENT RESOLVE in Iraq and Syria and Operation RESOLUTE SUPPORT in Afghanistan, and are forward deployed and ready to respond to any ongoing or emerging crisis or contingency. The 3rd MAW has a well-proven, colorful battle history. As part of the nation's force in readiness, the Marines and Sailors of 3rd MAW stand prepared to meet any and all challenges the future may bring. PREPARED IN PEACE AND WAR- SEMPER FIDELIS.

ABOUT

[Units](#)

[News](#)

[Photos](#)

[Leaders](#)

[Marines](#)

[Family](#)

[Community Relations](#)

CONNECT

[Contact Us](#)

[FAQS](#)

[Social Media](#)

[RSS Feeds](#)

LINKS

[Accessibility](#)

[USA.gov](#)

[No Fear Act](#)

[FOIA](#)

DOWNLOAD OUR MOBILE APP



[Privacy Policy](#) | [Site Map](#) | © 2022 Official U.S. Marine Corps Website

Hosted by Defense Media Activity - WEB.mil

VMM-364 HISTORY

HISTORY

Marine Medium Helicopter Squadron 364 was originally commissioned as Marine Light Helicopter Squadron 364 on 1 September 1961 at Marine Corps Air Facility Santa Ana, CA. In November 1961, it received delivery of its first Sikorsky H-34 helicopter and in February of 1962, the designation of the squadron was changed to HMM-364 in 1962.

In the spring of 1962, the squadron participated in Mid-Pacific operations to assist in recovering instruments that had been used in the atomic test program. In November 1963, the squadron deployed to Okinawa and subsequently to Da Nang, Republic of Vietnam. The squadron served in Vietnam until July of 1964. Eight months later the squadron was back in South Vietnam, this time conducting operations with the Special Landing Force of the Seventh Fleet. HMM-364 remained in Vietnam until September of 1966. The squadron was then placed in cadre status at Marine Corps Air Station, El Toro, CA, and consisted of three officers and 12 enlisted Marines. In March of 1967, the squadron was reorganized and began receiving delivery of the then-new Boeing CH-46 Sea Knight helicopter. In October of that year, HMM-364 re-deployed to the Republic of Vietnam, initially to Phu Bai and eventually to Marble Mountain. HMM-364 participated in Operations Osceola, Kentucky, Mameluke Thrust, and Hue City and finally in the evacuation of the embassy in Saigon. For almost half of its short 10-year existence, HMM-364 had served in the Republic of Vietnam. It was at this time that the squadron adopted the "Purple Fox" name. During the three tours in Vietnam, the squadron's pilots and crewman flew almost 70,000 hours in combat and combat support missions and were awarded the Presidential Unit Citation for meritorious conduct in the performance of duty. As our nation briefly stepped-down from its wartime posture in the early 1970s, so did the Foxes. On 22 March 1971, the squadron folded its colors and was decommissioned.

On 28 September 1984, HMM-364 was reactivated at Marine Aircraft Group 24, Marine Corps Air Station (MCAS) Kaneohe Bay, Hawaii. Throughout the 1980s and early 1990s, the squadron enjoyed many Western Pacific deployments. The Foxes participated in Team Spirit 1986 and 1988 at Pohang, Korea in support of III Marine Amphibious Force. In February 1990, the Purple Foxes deployed to Okinawa, participating in numerous Special Operations Capable (SOC) missions and supported Team Spirit '90 together with a detachment of six CH-46s. From August 1990 to March 1991, HMM-364 was placed in reserve during Operations Desert Shield/Desert Storm, becoming the sole supporting squadron for 1st Marine Expeditionary Brigade. In June 1991, the Purple Foxes once again deployed to Okinawa. During the deployment, the squadron supported Marine Air Ground Task Force 4-90 in the Philippines, assisting with the relief efforts following the eruption of Mt. Pinatubo and participating in joint exercises in Korea and Japan. Early the following year, the Purple Foxes headed for the Hawaiian island of Kauai, performing humanitarian relief due to the devastation left by Hurricane Iniki. From January to July 1993, the Purple Foxes again deployed to Okinawa. The squadron participated in exercise Team Spirit, Korea, as well as serving as the Aviation Combat Element of the 35th Marine Expeditionary Unit aboard the USS Belleau Wood during Cobra Gold 1993. ▲

In August 1995, the Purple Foxes packed up and embarked upon USS Tarawa to move to MCAS El Toro. That same year, HMM-364 was selected to be the Aviation Command Element for Special Marine Air-Ground Task Force Experimental [SPMAGTF (X)] SEA DRAGON. This very important and high visibility project was an exercise conceived by the Commandant's Warfighting Laboratory (CWL) to develop and test methods and techniques for the 21st century battlefield. In February 1996, the Purple Foxes again made headlines by providing Executive Transport for President Clinton and other dignitaries while they toured flood-damaged Portland, Oregon. This marked the first time in history that a U.S. President had flown in a Fleet Marine Force helicopter. In July 1998, HMM-364 (REINFORCED), 13th MEU ACE, participated in RIMPAC 1998 while conducting the pre-deployment work-up schedule associated with a MEU(SOC) squadron. On December 5, the squadron embarked aboard USS Boxer, participating in Operation Southern Watch and various split-ARG operations off the Horn of Africa, as well as supporting exercise EAGER MACE, Kuwait.

In June of 1999 the Purple Foxes returned from deployment and moved into their current home at Marine Aircraft Group 39 aboard Marine Corps Air Station Camp Pendleton, CA. The Purple Foxes began training to their new core competency as part of 3d MAW's "Fly-In" echelon for contingency operations. With the new focus of deploying by strategic lift and naval shipping, the Purple Foxes spent much of the next two years supporting Combined Arms Exercises, participating in Combat Readiness Evaluations, and supporting Marine training aboard Camp Pendleton. In October 2000, the squadron embarked aboard USS Peleliu to maintain proficiency in shipboard operations; later in the deployment, the squadron was also a guest of both USS Bonhomme Richard and USS Peleliu in support of Operation KERNEL BLITZ.

In August of 2001, having been assigned to support I MEF, HMM-364 was tasked to support exercise RSO&/FOAL EAGLE 2002. As this concept unfolded, a pre-deployment work-up cycle took place at an expeditionary Forward Operating Base at Fort Hunter-Liggett, CA in support of exercise SEAHORSE WIND. Further workup training was conducted in the form of a combined MCCRE with HMLA-369 at NAF El Centro, STRATMOBEX from March ARB to Edwards AFB, and cold-weather training at the Marine Corps Mountain Warfare Training Center Bridgeport, CA, all while concurrently standing by for immediate tasking resulting from the events of 11 September 2001. The capstone event was the deployment to the Republic of Korea to participate in the annual RSO&/FOAL EAGLE Exercise from January to April 2002. HMM-364 was the first Marine Helicopter Squadron to deploy using contract Russian AN-124 aircraft, as well as USAF C-5 Strategic Lift. The squadron flew missions in support of Special Warfare Command and the Korean Combined Rescue Coordination Center.

With a desert deployment looming on the horizon, the Purple Foxes sent detachments to Yuma, AZ and Fallon, NV to perfect desert-flying skills in both day and night regimes, as well as to support CAX 02-03. Following CAX, the squadron deployed twelve CH-46Es and all squadron personnel to Kuwait. In January 2003, all twelve aircraft were flown from MCAS Camp Pendleton to NAS North Island, "shrink-wrapped," and craned into the hull of USS Pollux, a USNS Fast Surface Shipping vessel, another first for the transportation of CH-46Es in Marine Corps history. Several squadron Marines were assigned as the security force for the vessel while the Main Body was flown to Ali Al Salem Air Base, Kuwait. By the end of February, USS Pollux had reached Kuwait and the off-loaded aircraft were flown to Ali Al Salem. In conjunction with MAG-39 and its augments, HMM-364 began mission planning and rehearsals for combat operations against Iraq.

Operation IRAQI FREEDOM commenced on the evening of 20 March 2003, following preliminary strikes by coalition forces. HMM-364 was involved from the first night, supporting attacks by the 1st Marine Division's Regimental Combat Team 7 and the British 42nd Commando. Squadron aircrews conducted Casualty Evacuation (CASEVAC) missions in direct support of RCT-7 for the duration of the war, traveling with the 1st Marine Division from Al Basra to downtown Baghdad. With the conclusion of hostile operations in Iraq on 17 April 2003, HMM-364 continued to fly CASEVAC and Logistical Support for Marine Corps humanitarian aid on behalf of the Iraqi people. After nine months of successful operations in its first combat theater since Vietnam, HMM-364 returned to MCAS Camp Pendleton in October of 2003.

The Purple Foxes were destined to see the Iraqi deserts again. On 1 March 2005, the squadron effected a relief-in-place with HMM-268 at Al Taqaddum, Iraq, thereby assuming duties as the primary CASEVAC squadron for the troubled Eastern Al Anbar province, during OIF III. Over the course of their seven-month deployment, the Purple Foxes saved over 300 Coalition and civilian lives and performed several multi-aircraft raids in conjunction with various Recon units to seek out insurgents traversing the rural highways south of Fallujah. The uncompromising speed and determination with which the Foxes answered every CASEVAC bell and conducted every raid revived the squadron's decades-old motto, "Give a Shit," which adorns the squadron patch the crews wear in combat.

▲

During OIF 05-07.2, HMM-364 once again assumed the primary CASEVAC role as they conducted a relief in place with HMM-268 on 29 August 2006. Throughout the deployment, HMM-364 answered the bell to the toll of 3,911 combat sorties, 2,307 Casualty Evacuations and 6,373 flight hours in a mere seven months.

HMM-364's relentless devotion to duty was displayed during the October 2007 California wildfires. Operating with minimal personnel due to base closure and prior to requests for assistance, HMM-364 readied all squadron aircraft for firefighting operations. The squadron's perseverance helped contain multiple base fires, saved livestock boarded at base stables, and prevented millions of dollars of damage to the San Luis Rey Base Housing community.

The squadron deployed to Yuma, Arizona in December 2007 for a Detachment for Training (DFT) prior to participating in Desert Talon 1-08, as a final preparation for the squadron's return to Al Taqaddum, Iraq. The squadron's main body departed Camp Pendleton on 10 March 2008 and arrived at Al Taqaddum, Iraq shortly thereafter in support of OIF 08.1. The Purple Foxes returned stateside in October 2008, and immediately began preparing for another deployment in October 2009 by sending a Detachment for Training to Nellis AFB, NV, in December, less than two months after returning CONUS.

The Foxes continued preparations for their fifth OIF tour by deploying in August 2009 to Twentynine Palms, CA, for Enhanced Mojave Viper (EMV) 14/15. At EMV HMM-364 received excellent reviews and set the bar yet again for other units to emulate. With little downtime in September (the advanced party departed mid-month) HMM-364 deployed to Al Asad, Iraq in early October 2009 in support of OIF 09.2, the squadron's last deployment to Iraq.

The Purple Foxes took the medium lift mission from HMM-268 on 15 October 2009. During a four month deployment, HMM-364 flew 2,253.0 flight hours, moving over 6,500 passengers and 147,000 pounds of cargo. In January of 2010, HMM-364 sent the first five aircraft home from Al Asad. With only eight remaining aircraft, the squadron continued to operate a full flight schedule. The final eight aircraft were loaded onto Russian AN-124 aircraft for return to CONUS days after the last mission was flown in Iraq. HMM-364 returned home to Camp Pendleton in early February of 2010 as the last operating Marine Aviation unit in support of Operation IRAQI FREEDOM.

Once aboard Camp Pendleton, the squadron shifted its focus to shipboard operations. In September of 2010, The Purple Foxes received the order to support the 11th MEU aboard USS Makin Island for San Francisco Fleet Week while at the same time, supporting WTI class 1-11. In September, the squadron sent five aircraft to Yuma, AZ for WTI and a week later flew five more aircraft aboard USS Makin Island in support of San Francisco Fleet Week. This marked the first time HMM-364 had conducted ship board operations in over 10 years.

The overriding focus of effort during the beginning of 2011 was a DFT to Davis-Monthan Air Force Base to support Third Air and Naval Gunfire Liaison Company (3rd ANGLICO) by assisting in the training and evaluation of their Joint Terminal Attack Controllers (JTACs). Not long after, the squadron participated in the Naval Aviation Centennial launching a division in a formation flight of eight CH-46Es, which flew among two-hundred total aircraft commemorating the Centennial of Naval Aviation. Additionally, the squadron was tasked with flying several Pax, Mail, and Cargo (PMC) missions to USNS Curtiss in support of Operation Pacific Horizon, and this provided an opportunity to conduct initial and refresher day Carrier Qualifications.

May 2011 began with the support of the Marines of Golf Company, under Marine Special Operations Command (MARSOC), to execute MRX Raven 11-02 in preparation for an upcoming OEF deployment to Afghanistan.

During June 2011, the squadron focused on its own internal training, specifically on Mountainous Area Training (MAT), with a DFT to the Marine Corps Mountain Warfare Training Center (MCMWTC), located in Bridgeport, CA. This DFT allowed the squadron to refocus on basic preflight planning and flying in demanding environmental conditions.

On 1 September 2011, the 50th Anniversary of the Purple Foxes, the squadron deployed eight aircraft and the squadron's Marines to 29 Palms in support of Mojave Viper (MV) 8-11. During the course of the three week combined arms exercise, HMM-364 was tasked with assault support missions in an austere environment.

The month of October 2011 began with the squadron once again supporting San Francisco Fleet Week; this time aboard USS Bonhomme Richard (LHD 6). Even after returning from Mojave Viper four days prior, HMM-364 embarked two aircraft and 42 personnel in order to participate in San Francisco Fleet Week and conduct shipboard training.



On 21 February 2012, HMM-364 became a composite squadron and assimilated detachments from HMLA-367, HMH-361, MWSS-372, MWSS-374, and MACG-38 to become HMM-364 (Reinforced), the Air Combat Element of the 15TH MEU. The next seven months were followed by the intense MEU work-up cycle including training ashore and afloat in areas ranging from Yuma, AZ; El Centro, CA; Pt Mugu, CA; Fort Hunter-Liggett, CA; San Clemente Island; Camp Pendleton; and the greater Los Angeles area.

On 17 September 2012, the squadron embarked 29 aircraft including 12 CH-46Es, 4 CH-53Es, 4 AH-1Zs, 3 UH-1Ys, and 6 AV-8Bs onboard USS Peleliu and USS Green Bay and deployed as the 15th MEU ACE. From 10-16 October 2012, the 15th MEU executed Operation CROCODILO, a humanitarian relief operation in the country of East Timor. Upon completion of Operation CROCODILO, the 15th MEU sailed further west and split the Amphibious Readiness Group (ARG) to support multiple tasks, where it remained for the rest of 2012. The squadron detachment aboard USS Green Bay supported Theater Security Cooperation (TSC) exercises Iron Magic in the United Arab Emirates (UAE). Following training in UAE, USS Green Bay steamed to Saudi Arabia for TSC Red Reef and Eager Mace in Kuwait. Aboard USS Peleliu, the squadron conducted sustainment and proficiency training in Djibouti, Africa. The AV-8B's conducted effective bi-lateral Air Interdiction training with the French Air Force. In December, the battle proven CH-46E was tasked with providing VIP movement for the Commandant of the United States Marine Corps from Salalah, Oman to USS Peleliu.

The ACE continued to maintain its readiness before departing the 5th Fleet AOR on 4 April. On 12 and 13 May 2013, HMM-364 (REIN) disembarked all personnel, critical equipment, and 29 aircraft from USS Peleliu and USS Green Bay.

In September 2013, the squadron conducted a DFT to support 1st Battalion, 10th Marines at the MCMWTC in Bridgeport, CA. In November, HMM-364 executed a DFT in support of Mission Rehearsal Exercise Raven 14-01 in Fort Irwin, CA (National Training Center) in support of Marine Corps Forces Special Operations Command (MARSOC).

In March 2014, HMM-364 executed back to back DFTs. From 3 – 11 March, HMM-364 deployed Four CH-46E aircraft to the National Training Center in Fort Irwin, CA in support of Marine Special Operations Command Mission Rehearsal Exercise Raven 14-02.

On the heels of completing Exercise Raven 14-02, HMM-364 deployed a total of eight CH-46E aircraft in three waves to Mountain Home Air Force Base in Mountain Home, Idaho from 12 – 21 March in support of Exercise Gunfighter Flag, an Air Force training exercise that involved air-to-ground ordnance delivery from multiple types of aircraft, including Marine Light Attack Squadron 469 and F-15 fighters from Singapore.

In May 2014, the squadron was tasked to support HMX-1 for a high priority presidential visit and movement in downtown Los Angeles, CA with four CH-46E aircraft. Additionally, the squadron supported an Urban Search and Rescue FRAG in support of California Task Force Five. Finally, the squadron conducted six consecutive days of firefighting in support of California Fire Authority as multiple fires raged through Southern California, both on Camp Pendleton and in neighboring cities.

In July through September, HMM-364 supported Partnership of the Americas (POA), a six week exercise in Chile. HMM-364 partnered up with the Chilean Air Force throughout this exercise for training and building international relations. Following completion of the exercise the squadron returned on board the USS America.

Once back in San Diego HMM-364 continued retiring aircraft to the Boneyard at Davis Monthan Air Force Base. On 9 October 2014 LtCol Paul B. Kopacz took command of the Purple Foxes signaling the official beginning of the transition to the MV-22B Osprey platform and transition to Marine Medium Tiltrotor Squadron 364 (VMM-364).

Since the transition to a tiltrotor squadron, the Marines of VMM-364 have repeatedly demonstrated their exceptional dedication to duty and each other. Through multiple site training evolutions on both MCAS Camp Pendleton and Miramar, working with five different squadrons, the enlisted Marines and officers have worked together to achieve Safe for Flight and Initial Operationally Capability designations as well as gaining great knowledge on their weapons systems. In addition to the minimum required designations, the squadron also produced an additional two basically qualified copilots. While only having half the required allotment for aircraft, the maintenance department was able to provide available aircraft comparable to a full squadron. The operations department was able to capitalize on this and make significant progress in core plus training for all aircrew.



All of these significant achievements occurred while the squadron was operating in an austere setting of temporary buildings and without a hanger capable of supporting MV-22B specific maintenance. The Marines of VMM-364 had again shown their dedication to the Marine Corps and each other by being successful under any condition.

The squadron conducted a Detachment for Training (DFT) in Navy Air Facility El Centro from 4 December to 10 December 2015. Five aircraft departed Marine Corps Air Station Camp Pendleton signifying another major achievement, the squadron's first internal MV-22 flight of aircraft. While on DFT the squadron conducted formation, tail gunnery, reduced visibility landings and ground threat reaction training. Each shop in the squadron exercised their embark and movement plans while simultaneously preparing for the squadron move into Hanger 6, MAG-39s first MV-22 specialized hanger space.

In June 2016, the squadron operated out of Reno-Stead airport with support from the 1-189th General Support Aviation Battalion in support of "Mountain Exercise" at the Marine Corps Mountain Warfare Training Center (MCMWTC) in Bridgeport California. This was followed by a two week detachment to Mountain Home AFB in Mountain Home Idaho beginning on 16 August 2016. Like the squadron's previous detachment at MCMWTC, Mountain Home brought pilots and aircrew training environments and challenges far different from those regularly experienced in Southern California. Preparation for deployment culminated in January 2017 with participation in Integrated Training Exercise 2-17 held in Twenty-nine Palms California.

From 4 April to 13 October 2017 VMM-364 departed Camp Pendleton for the squadron's first deployment as a VMM to support Special Purpose Marine Air Ground Task Force Crisis Response Central Command (SPMAGTF-CR-CC) based at Al Jaber Airbase Kuwait. During this period VMM-364 flights supported Operation INHERENT RESOLVE playing an important role in coalition efforts to defeat the Islamic State. In total 545.9 combat hours were flown transporting 100,162 pounds of cargo and 1,803 passengers over Iraq, Syria, and other Arab nations.

Upon returning from Kuwait in October 2017, the Purple Foxes resumed operations at Camp Pendleton for the winter. With lots of comings and goings, the squadron had a quiet fall but hit the ground running in the winter and spring. From 8-18 May, the squadron operated out of Creech AFB in support of unit level training for Ground Threat Reaction training and Reduced Visibility Landings. The DFT at Creech afforded the Foxes the opportunity to operate in a challenging environment for aircrew and maintainers. During the DFT, the Purple Foxes worked closely with the 42nd Attack Squadron and Charlie Company, 1st Battalion, 7th Marines to execute a Long Range Raid from Twentynine Palms to the Creech range complex.

After the Creech DFT, the Purple Foxes continued churning for the summer, producing flight leadership designations, instructor qualifications, and mission-qualified co-pilots at the cyclic rate, all while integrating with 1st Battalion, 7th Marines in order to prepare both units for their upcoming deployment in support of SPMAGTF-CR-CC 19.2 in the spring of 2019. The highlight of the Purple Foxes support was a Commandant of the Marine Corps movement which also occurred in May of 2018. The Purple Foxes executed many cross countries, travelling across the United States to Seattle, Denver, Palm Springs, El Centro, Austin, Boise, and San Francisco. All of this training was done in preparation for the squadron's upcoming deployment in support of SPMAGTF-CR-CC.

Between September and December 2018, the squadron's maintenance department conducted an ALMAT inspection and finished with a 97.6%, a 3d MAW record. CNAF inspection followed, which saw the maintenance department set another 3d MAW record with a 98.2% and finish in the top 10 of all Navy and Marine Corps squadrons. The Purple Foxes conducted a Marine Corps Combat Readiness Evaluation (MCCRE) in Twentynine Palms, California in November and a Certification Exercise in Yuma, Arizona in December in preparation for the upcoming deployment.

On January 11, 2019, the Purple Foxes launched nine planes to Twentynine Palms, California in order to self-deploy the squadron to support Integrated Training Exercise (ITX) 2-19. In doing so, 364 was the first squadron to achieve the 3d MAW Commanding General Aircraft Readiness Show of Force Initiative. During the 6 week exercise, the Purple Foxes focused on proficiency in Reduced Visibility Landings in a dynamic environment, as well as demonstrated the squadron's ability to function as part of a MAGTF. ITX provided an excellent opportunity to integrate with the MAGTF as the Purple Foxes worked with HMLA-369, VMGR-352, VMA-311, VMU-1, DASC, 6th Marine Regiment, their brother battalion 1st Battalion, 7th Marines, 3rd Battalion, 3rd Marines, and other units from the GCE and LCE. At ITX, the squadron flew 464.8 hours in support of the exercise and in order to prepare for the upcoming deployment to CENTCOM.

▲

On March 31, 2019 the Purple Foxes arrived in Kuwait for a six month deployment to Ahmed Al Jaber Air Base. On April 13th, 2019, VMM-364 conducted a Transfer of Authority (TOA) with VMM-165 and the Purple Foxes began providing the tiltrotor crisis response air mobility for Special Purpose Marine Air Ground Task Force-Crisis Response-Central Command (SPMAGTF-CR-CC) 19.2. Like the previous deployment, the squadron provided vital medium lift support in direct support of combat operations for Operation INHERENT RESOLVE, while providing a CENTCOM theatre-wide alert, because of the strategic length of flight legs the MV-22 could provide. In July 2019, the squadron sent a multi-aircraft detachment to Africa to maintain an alert in support of a Joint Task Force conducting a national level mission for the remainder of the deployment. In doing so, the Purple Foxes became the first MV-22 squadron to provide sustained direct support to a Joint Task Force in the area of operations. Overall, The Purple Foxes flew over 1,200 combat hours across Iraq and Syria, which directly contributed to coalition efforts to defeat the Islamic State. Within those hours, the squadron moved over 3,000 passengers and over 450,000 pounds of cargo throughout Kuwait, Iraq, Syria, the Arabian Peninsula, and Jordan. All of this was accomplished as the squadron became the first MV-22 squadron to fly combat operations in three separate countries from two continents simultaneously.

VMM-364 finished fiscal year 2019 as the only VMM squadron to fly every one of their monthly, quarterly, and fiscal year flight hour goals. In total, the squadron flew 3,463 hours for fiscal year 2019 and, by doing so, flew more hours than any other VMM squadron in the last 10 years.

Following completion of tasking for Operation Inherent Resolve in October of 2019, VMM-364 returned to MCAS Camp Pendleton, California. In the following months, VMM-364 settled into operations at home with the acceptance of aircraft, support of various exercises such as Winter Fury and Steel Knight, and progression of flight leadership qualifications within the squadron.

On March 13th, 2020, VMM-364 was awarded the Fred McCorkle Award for Marine Medium Tiltrotor Squadron of the Year. This award positioned VMM-364 as the premier tiltrotor squadron within Marine Corps Aviation, and served as a testament to the Purple Foxes' dedication to their mission.

In October and November of 2020, the Purple Foxes participated in Service Level Training Exercise (SLTE), formerly known as Integrated Training Exercise (ITX), at Marine Corps Air Ground Combat Center, Twenty-nine Palms. Because of the unprecedented COVID-19 pandemic, VMM-364 elected to support the exercise from MCAS Camp Pendleton in order to mitigate the spread of the virus. This atypical method of support came with unique challenges including planning and execution alongside various units supporting from different locations. Despite these challenges, VMM-364 supported a total of 21 events, flew 300.3 aircraft hours, as well as transported 944 passengers and 5,050 pounds of cargo in direct support of SLTE. Units supported included 3d Battalion, 3d Marines, 2d Battalion, 1st Marines, 2d Battalion, 2d Marines, 2d Battalion, 6th Marines, 2d Battalion, 11th Marines, 2d Light Armored Reconnaissance Battalion, and the 10th Special Forces Group. The Purple Foxes also completed a Marine Corps Combat Readiness Evaluation (MCCRE) during SLTE in preparation for their upcoming deployment.

In March of 2021, VMM-364 deployed to CENTCOM and AFRICOM areas of operation in support of SPMAGTF-CR-CC. After conducting transfer of authority from VMM-362 at Al Jaber Airbase, Kuwait, and Camp Lemmonier, Djibouti, VMM-364 was tasked to move all assets and personnel from Al Jaber and Camp Lemmonier to Prince Sultan Airbase, Saudi Arabia. Upon movement of aircraft and personnel to Prince Sultan Airbase, VMM-364 demonstrated its' ability to conduct long range missions from a new and austere location. Logistical and operational challenges involved with basing operations out of Prince Sultan Airbase were numerous. Despite these difficulties, VMM-364 was able to successfully support two Geographic Combatant Commands from a single location. During the deployment, the Purple Foxes conducted training aboard the USS Lewis B. Puller to include initial Carrier Qualification for aircrew. VMM-364 also participated in TRAPEX, a personnel recovery exercise involving ship-to-shore transport of a recovery team to an isolated person. This exercise demonstrated the SPMAGTF capability to conduct ship-to-shore, long-range personnel recovery missions in an austere environment, crossing multiple national borders. During the deployment, VMM-364 flew 1414.5 total hours in support of training and operations, including 458.5 hours of contingency support to Operation Inherent Resolve and Operation Enduring Freedom – Horn of Africa.

VMM-364 returned from CENTCOM in October of 2021. Acceptance of aircraft and personnel continued through the year as the Purple Foxes settled back in to training operations at home. From December 2021 to May 2022, VMM-364 participated in various large-scale exercises to include Steel Knight, Winter Fury, and Jaded Thunder. On May 20, 2022 VMM-364 conducted Change of Command and welcomed the Purple Foxes' newest Commanding Officer. 

V-22 OSPREY



Primary function: Amphibious assault transport of troops, equipment and supplies from assault ships and land bases.

Manufacturer: Bell Boeing

Description: The V-22 Osprey is a multi-engine, dual-piloted, self-deployable, medium lift, vertical takeoff and landing (VTOL) tilt-rotor aircraft designed for combat, combat support, combat service support, and Special Operations missions worldwide. It will replace the Corps' aged fleet of CH-46E and CH-53D medium lift helicopters.

Unit Replacement Cost: Unit Cost (FY05 \$ TY Unit Recurring Flyaway Costs): \$89.8M

Mission: Marine Corps Assault Support

Variants: The CV-22 will be utilized by the Air Force and SOCOM for Special Operations missions maintaining maximum commonality with the MV-22. Aircraft avionics peculiar to Air Force/SOCOM unique mission requirements constitute primary aircraft differences. The Navy will use the HV-22 for Combat Search and Rescue and fleet logistics support.

Deployed to: The MV-22 will be transitioned to all Marine Corps medium lift active duty and reserve tactical squadrons, the medium lift training squadron (FRS), and the executive support squadron (HMX).

They will deploy as required in a similar manner that current medium lift units are deployed. IOC is FY07.

Dimensions:

Spread / Folded

Length.....57' 4" / Length.....63' 0"

Width.....84' 7" / Width.....18' 5"

Height.....22' 7" / Height.....8' 3"

Takeoff Weights:

Vertical Takeoff/Landing (VTOL).....52,600 lb

Short Takeoff/Landing (STOL).....57,000 lb

Self Deploy STO.....60,500 lb

Key Performance Parameters: (MV-22 OpEval demonstrated values in parentheses):

OPEVAL was conducted from March to June 2005 and found to be operationally effective, operationally suitable and recommended for Fleet introduction.

Mission Range:Amphibious Pre-Assault Raid 200 nm (230nm)

Amphibious External Lift with 10,000 lb load 50 nm (50nm)

Land Assault External Lift 50nm (69nm)

Troop Seating, 24 Combat Troops (24 Combat Troops)

Self-Deployment 2100 nm (2113 nm)

Cruise Airspeed: MV-22 240 kts (255 kts)

CV-22 230 kts

Aerial Refueling Capable & Shipboard Compatible

Initial Operational Capability: 2007

Number Procured (authorized through FY05): 76 MV-22

Prime Contractor(s): Boeing Defense and Space Group, Phila, PABell Helicopter

Textron, Ft Worth, TXRolls Royce, Indianapolis, IN

Planned Inventory: 360 MV-22 (USMC)50 CV-22 (USAF)48 HV-22 (USN)

Source: <https://www.aviation.marines.mil/About/Aircraft/Tilt-Rotor/>



Commandant of the Marine Corps - Safety Division

MV-22 Comparative Mishap Statistics

July 6, 2022

Prepared by _____, Safety Division

Enclosure (7)



MV-22B Background

- The United States Marine Corps (USMC) has 18 MV-22B Squadrons
 - 15 Operational / 2 Reserve / 1 Training
- The MV-22B is the Assault Support backbone of Marine Expeditionary Units
- The Aircraft is manned for 2 pilots and no less than 1 Crew Chief.
 - Normal operations can call for up to 3 Crew Chiefs / Aerial Observers
- All MV-22 Pilots receive standardized initial training at VMMT-204 New River NC before assignment to Fleet Marine MV-22B squadrons.
- Fleet Marine Squadrons receive MV-22B from VMMT-204 and train the aircrew in fundamental combat operations to provided combat capable aircrews.
- Advanced instructor training and qualification is standardized, executed by the Marine Aviation Weapons and Tactics Squadron One (MAWTS-1)
 - The MAWTS-1 executes a bi-annual Weapons and Tactics Instructor course that trains the most qualified and experienced squadron pilots and aircrew in advanced combat. These aircrew return to their squadrons and serve as instructor pilots.



MV-22B Background

- Is the Osprey a safe aircraft? Absolutely.
- In the past 10 years, Marine Corps MV-22's have flown well over 420,000 flight hours, with more than half of that number coming in the past five year alone. (Five year average: about 44,000 hours per year)
- Marine Ospreys fly about twice as many hours as our other Rotary Wing platforms do. Marine MV-22's are the workhorse of our Assault Support community, and the extensive capabilities far exceed those provided by its predecessor, the CH-46.
- The 10 year average mishap rate for MV-22's is 3.16 per 100,000 flight hours. That is lower than AV-8, F/A-18A-C, F-35B, and CH-53E. It is also on par with the total USMC average (3.1) which includes aircraft like KC-130J, which average much longer mission times.
- Including the two MV-22 mishaps in FY22, the USMC MV-22 fleet has only had three Class-A Aviation mishaps in the past five years combined. While our mishap rates use a 10 year scale, the past five year average rate for Ospreys is much lower at only 1.5 per year.
- In FY22, the USMC has had two very high profile Class-A mishaps since March.
- This has drawn quite a bit of attention. No mishap is ever acceptable. That said, the gravity of these two mishaps is highlighted by the many hundreds of thousands of hours that our Ospreys have operated safely - in every clime and place- throughout the globe.
- The USMC is very good at mishap investigations, and in due time we will know the causes for the two mishaps this year. When those investigations are released, the Safety Division will ensure that any lessons learned are shared to all stakeholders so that we can continue to train and fight as effectively and safely as possible.



FY11-22 Marine Corps MV-22B Mishap Short Narratives

USMC MV-22B AVIATION CLASS A MISHAPS (includes FRMs and AGMs)

- 07 July 2011: (Helmand Province, Afghanistan) Marine E-6 fell from a MV-22B during aircraft departure from LZ. 1 Fatality. (FRM)
- 11 Apr 2012: (Morocco) MV-22B crashed during day VFR departure from LZ in Morocco. 2 fatalities, \$79,300,000.
- 21 Jun 2013: (Dare Range, NC) MV-22 sustained fire damage during landing on unprepared surface. No fatalities, \$63,483,326.
- 26 Aug 2013: (Indian Springs, NV) MV-22 sustained hard landing while executing reduced visibility landing practice. No fatalities. \$75,086,565.
- 19 May 2014: (Harold, NC) Crew Chief died after falling from a MV-22B during a training flight. 1 fatality. (FRM)
- 01 Oct 2014: (NAG) MV-22 sustained engine degradation after takeoff from ship. Aircraft was able to recover aboard ship. Both crew chiefs egressed from aircraft. One crew chief lost at sea. 1 fatality. \$1,309,648.
- 17 May 2015: (Marine Corps Training Area Bellows, HI) MV-22B sustained a hard landing during a training exercise. 2 fatalities. \$80,600,000.
- 09 Dec 2015: (Off the Coast of CA) MV-22B landed short while recovering to LPD. No fatalities. \$2,000,001.
- 13 Dec 2016: (Off the Coast of Okinawa, Japan) MV-22B attempted a precautionary emergency landing (PEL) to dry land but crash landed in shallow water. Crew of 5 evacuated with injuries. No fatalities. \$83,700,000.
- 11 Jul 2017: (New River MCAS, NC) Maintenance personnel struck by lightning on the flight line while working on MV-22B. 2 were treated and released. 1 fatality. (AGM)
- 05 Aug 2017: (15 NE Shoal Water Bay, Australia) MV-22B struck LPD flight deck on final approach and then crashed into water. 3 personnel are missing and presumed deceased. 23 recovered. 3 fatalities. \$82,664,000.
- 28 Sep 2017:(Syria) MV-22B crashed on landing during support mission. No fatalities. \$67,223,637.
- 30 May 2020: (San Diego, CA) Civilian aircraft collided with a parked MV-22B Osprey. No fatalities. \$4,250,000.(AGM)
- 18 Mar 2022: (Norway) V-22 suspected control flight into terrain. 4 fatalities, \$89,800,000.
- 8 Jun 2022: (IVO Glamis, CA) V-22 impacted ground in Restricted Area 2512. 5 fatalities, \$89,800,000.

*cost excludes injury cost

*Includes FRM (Flight Related Mishaps) and AGMs (Aviation Ground Mishaps)

Enclosure (7)



USMC MV-22 Class A Mishaps

USMC: MV-22 Class A Aviation Mishaps

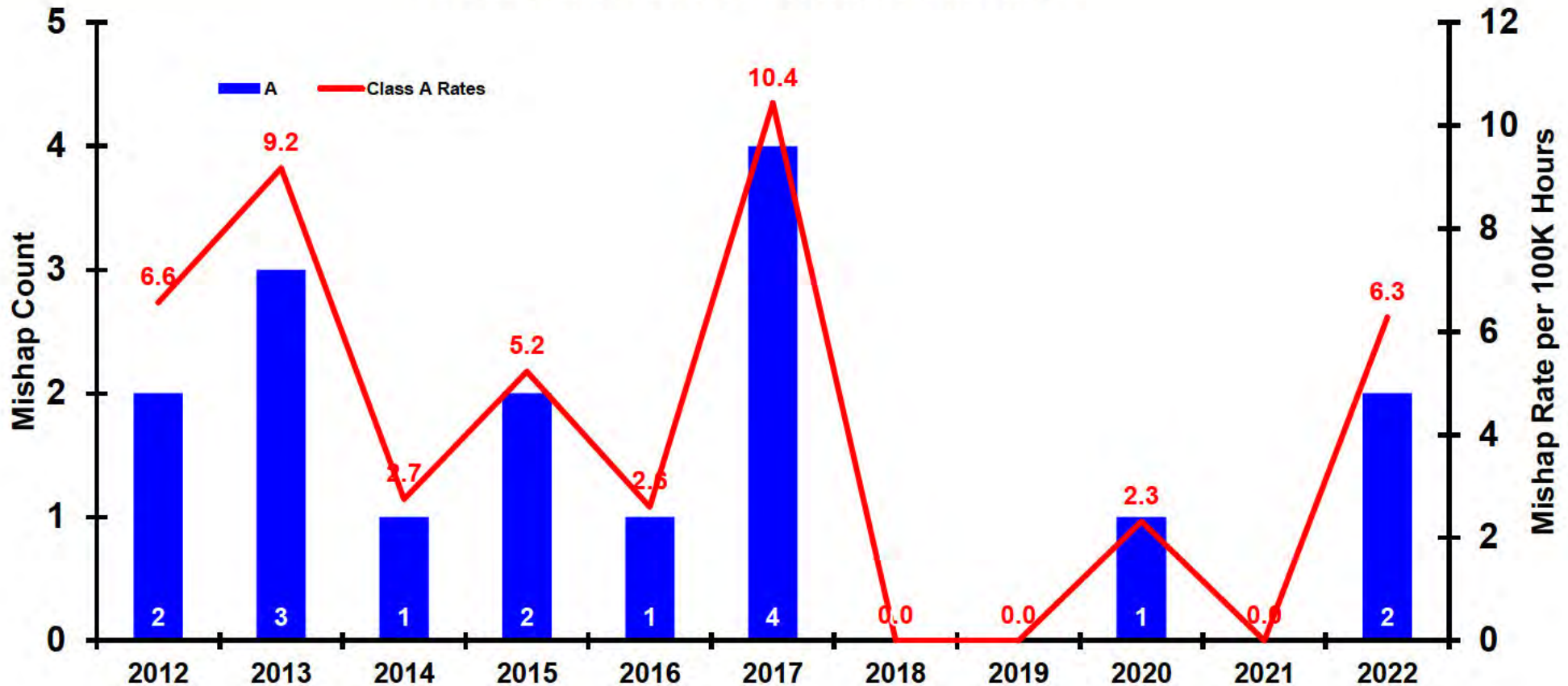

Class A Mishap: Fatality or occupational related illness causing Permanent Total Disability or property damage of \$2,500,000 or greater.



USMC MV-22 Class A-C Mishaps

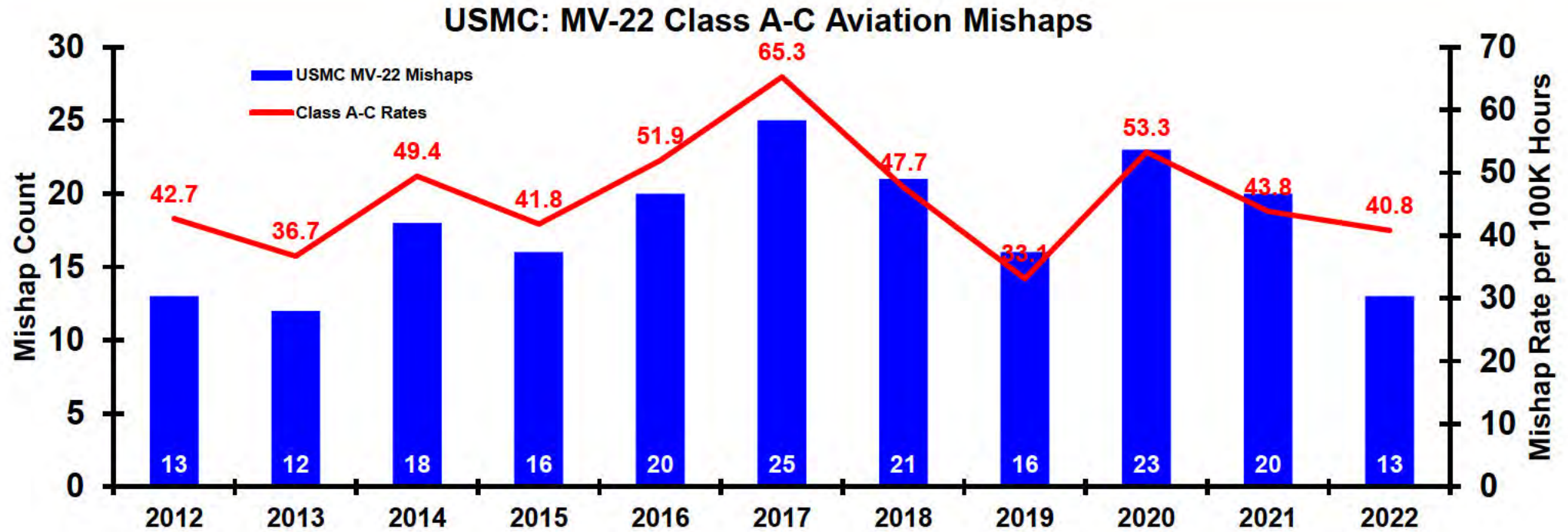

Class B Mishap: Hospitalization of 3 or more personnel in the same mishap, injury or occupational related illness causing Permanent Partial Disability (PPD) or property damage of \$600,000-\$2,499.999.

Class C Mishap Individual Injury causing a minimum of one (1) lost workday (including weekends), or occupational related illness or injury causing a minimum of (1) lost workday(including weekends) or property damage of \$60,000-\$599.999.

MARINE MEDIUM TILTROTOR SQUADRON OF THE YEAR

For meritorious service, professional achievement, and sustained superior performance from 1 January 2021 to 31 December 2021. The "Purple Foxes" of VMM-364 demonstrated their dominance across all combat operational domains sublimely blending tactics, risk management, and will-do warfighting esprit. The Purple Foxes fought in three countries from two continents, supported a National Mission Joint Task Force as a conventional tiltrotor unit, established new expeditionary advance airbase, and provided the first integrated forward staging in several austere locations, contributing to coalition forces' ability to close with and destroy Islamic State of Iraq and the Levant and Al Qaeda forces. The Purple Foxes managed risk across a wide spectrum of desert and littoral combat operations while surpassing the 10,000 hour mishap-free milestone with an unblemished 100 percent mission success rate. Through their continuous display of professionalism and total devotion to duty, the members of VMM-364 have upheld the highest traditions of the United States Marine Corps and the United States Naval Service.



VMM-364
MAG-39, 3D MAW



FRED MCCORKLE AWARD



Established in honor of Lieutenant General Fred McCorkle, whose leadership and dedication contributed to the success of the V-22 program, for the most outstanding tiltrotor squadron in Marine aviation.

SPONSORED BY
Bell-Boeing

Enclosure (8)

MV-22B TG T&R Events since 2012

MV-22B T&R Code	Crew Chief	Aerial Observer	Pilot
2540	4133	1237	4410
2541	12201	1924	14145
2542	3608	1535	4145
2543	11542	1950	12494
Total	31484	4650	35194



UNITED STATES MARINE CORPS
THIRD MARINE AIRCRAFT WING, FMF
MARINE CORPS AIR STATION MIRAMAR
P.O. BOX 452038
SAN DIEGO, CA 92145-2038

IN REPLY REFER TO
5830

24 Jun 22

From: 8042, USMC
To: Commanding General, 3d Marine Aircraft Wing, FMF
Subj: LINE OF DUTY PRELIMINARY INQUIRY INTO THE DEATH OF CAPTAIN
NICHOLAS P. LOSAPIO /7532 USMC
Ref: (a) JAGINST 5800.7G CH-1
Encl: (1) Appointing Order
(2) Personnel Casualty Report dtd 9 June 22
(3) VMM-364 Flight Schedule dtd 8 June 22
(4) OPREP-3 Serious Incident Report dtd 8 Jun 22

1. This reports completion of the preliminary inquiry conducted in accordance with reference (a) into the death of Captain Nicholas P. Losapio /7532 USMC on 8 June 2022.

2. Personnel contacted:

- a. USMC, Staff Secretary, 3d Marine Aircraft Wing,
- b. , USMC, Executive Officer, VMM-364,

3. Materials reviewed: Enclosures (1)-(4) were reviewed and all original copies are maintained by the Third Marine Aircraft Wing Office of the Staff Judge Advocate.

4. Summary of findings:

a. Paragraph 0215 of the reference states that a death incurred by a Marine on active duty is presumed to be “in the line of duty.” This presumption can only be overcome by “clear and convincing” evidence that certain circumstances existed at the time of death.

b. On 08 June 2022 Captain Losapio was on active duty in the United States Marine Corps, assigned to Marine Medium Tiltrotor Squadron 364 (VMM-364), Marine Aircraft Group 39 (MAG-39), 3d Marine Aircraft Wing (3d MAW), enclosure (2).

c. The Commanding Officer, VMM-364, MAG-39, 3d MAW, authorized a rear mounted weapon system (RMWS) training mission comprised of two Marine Medium Tiltrotor (MV-22B) aircraft in the R-2512 range complex near El Centro, California on 08 June 2022, enclosures (3) and (4). Captain Losapio was a member of the flight crew of the aircraft identified as Swift 11 in enclosure (3).

Enclosure (10)

Subj: LINE OF DUTY PRELIMINARY INQUIRY INTO THE DEATH OF CAPTAIN
NICHOLAS P. LOSAPIO /7532 USMC

d. Prior to the launch of the mission, the flight crews were briefed on the mission and conditions, and an Operational Risk Management assessment was conducted to ensure the safety of all personnel associated with the mission.

e. At approximately 1230 hours on 8 June 2022 Swift 12 lost sight of Swift 11. The pilot and crew from Swift 12 noted smoke and, upon closer inspection, evidence of a crash by Swift 11 in the R-2512 range complex in the vicinity of El Centro, CA. Enclosure (4).

f. The Imperial County Coroner's Office pronounced all pilots and crew of Swift 11 dead on 8 June 2022. Enclosure (2).

g. There is no evidence indicating any misconduct, intoxication or drug abuse in this case.

5. Recommendation: I recommend that Captain Nicholas P. Losapio be found to have died in the line of duty and not due to the member's own misconduct.

Controlled by: Department of the Navy
Controlled by: OSJA, 3d MAW (USMC)

POC: SJA, 3d MAW



UNITED STATES MARINE CORPS,

THIRD MARINE AIRCRAFT WING, FMF
MARINE CORPS AIR STATION MIRAMAR
P.O. BOX 452038
SAN DIEGO CA 92145-2038

IN REPLY REFER TO:
5830
OSJA
13 Jun 22

From: Commanding General, 3d Marine Aircraft Wing, FMF
To: USMC

Subj: COMMAND INVESTIGATION INTO THE CLASS A AVIATION MISHAP THAT
OCCURRED ON 08 JUNE 2022 IN THE R-2512 RANGE COMPLEX

Ref: (a) 10 U.S. Code, Section 2255
(b) JAGINST 5800.7G w/CH I (JAGMAN)

1. This Command Investigation (CI) is convened to investigate the circumstances surrounding a Class A aviation mishap in compliance with reference (a).
2. This letter appoints you in accordance with the references to investigate the cause and responsibility for the subject aviation mishap, the fatalities, description of all damage to property, and any attendant circumstances.
3. You are to complete both a line of duty determination Preliminary Inquiry (PI) and a Class A aviation mishap CI. Chapter II, Appendix A-2-k, and Appendix A-2-n of reference (b) are your governing reference materials. Templates for your PI and CI can be found at Appendix A-2-c and A-2-e, respectively.
 - a. You shall report your PI in writing by 14 calendar days from the date of this letter. If you require additional time, you shall submit a written request for such with detailed justification for any delay. Any request for extension shall be submitted via the 3d Marine Aircraft Wing's (3d MAW) Staff Judge Advocate (SJA). The request and associated response shall be included in your report.
 - b. You shall report your CI in writing by 60 calendar days from the date of this letter. If you require additional time, you shall submit a written request for such with detailed justification for the delay. Any request for extension shall be submitted via the 3d MAW SJA. The request and associated response shall be included in your report.
4. This is your primary duty until your PI and CI reports are completed, unless otherwise relieved of such duty by competent authority. Requests for additional support in your investigative efforts shall be submitted via the 3d MAW Chief of Staff. You are granted direct liaison authority with the senior member of the Aviation Mishap Board and with Naval Air Systems Command for requests related to this mishap.
5. You shall consult with the 3d MAW Director of Safety and Standardization and SJA on the conduct of your line of duty PI and aviation mishap CI.

Enclosure (10)

Enclosure (1)

Subj: COMMAND INVESTIGATION INTO THE CLASS A AVIATION MISHAP THAT OCCURRED ON 08 JUNE 2022 IN THE R-2512 RANGE COMPLEX

6. By copy to: of this order, _____ are appointed as your assistant investigating officers, unless otherwise relieved of such duties by competent authority, to provide technical expertise on investigations.

7. The point of contact for this matter is the 3d MAW SJA, _____ at _____

Copy to:
CO, MAG-39
CO. VMM-364

From:
Sent: Wednesday, June 8, 2022 7:43 PM
To: Casualty PCR USMC - Deceased
Cc:

Subject: 3MAW G-1 CASUALTY
Casualty Report - INIT - Losapio, Nicholas - Incident Date/Time: 2022/06/08
12:00
Attachments: Losapio_Nicholas_INIT_6-8-2022.rsfc
Signed By:

***** CASUALTY REPORT *****

Report Type: INIT
Casualty Type: Nonhostile
Casualty Status: DECEASED
Casualty Category: Accident
Report Number: VMJ22001
Personnel Type: Regular
Personnel Affiliation: Active Duty
Personnel Category: Obligated/Voluntary Service
Last Name: Losapio
First Name: Nicholas

Middle Name: Peter

Service: United States Marine Corps

Military Rank: CAPT

Military Unit of Assignment: VMM 364

Date/Time of Incident (New/Old): 20220608/1200

Incident City: Holtville

Incident State: CA

Incident Country: United States

Circumstance: An MV-22 Osprey crashed while conducting training at Range-2512 IVO of Holtville, California at approximately 1200 on 20220608.

Died in/out of Medical Facility Treatment: Died Outside A Medical Treatment Facility

Date/Time of Death: 20220608/1200

Place of Death City: IVO Holtville

Place of Death State: CA

Place of Death Country: United States

Cause of Death: Pending

Duty Status: Present For Duty

Remarks: A Command Investigation will be initiated. SNO was declared deceased by Competent Medical Authority Mike Mistriel, Imperial County Coroner (760) 339-6311. The unit point of contact is Executive Officer, VMM-364, or
The PCR Verifier is Commanding Officer, VMM-364,

Software Version: DCIPS Forward - Version 8.0 Build: 70 Release Date: 01 May 2014

<DCIPS Forward 8.0>

AIK95XVQXJHYNTSC

AIKXVQGJLNSC

NSXJWY NSYT IKdHFXZFQY^ HFXdWUYdNI1 NSNYdHFXdWUYdNI1 FWHMN[J1 HWJFYJIdKWTR1
HWdZXJWdNI1 HWdiYYR1 QRidZXJWdNI1 QRidYYR1 WUYdY^UdYGI1 HFXdWUYdSW1
HFXdNSNYdWUYdSW1 HFXdHFXJdHQXdY1 HN[dJRUdY^UJdHI1 HFXdNSHNISYdHI1
HFXdXYFYdFG1 HFXdHFYdHI1 XUhdNSY1 XUhdHFY1 YJWWdFHY1 HFXdUW[XdXYFYdHI1
HFXdUW[XdHFYdHI1 RZQYdHFXdJ[JSYdHI1 RZQYdHFXdJ[JSYdY]1 UJWXdY^UJdHI1
UJWXdRNQFKQdHI1 UJWXdHFYdHI1 NSIdXXS1 TQIdNSIdXXS1 NSIN[dQFXYSR1
NSIN[dKNWXYdSR1 NSIN[dRNIIQJdSR1 NSIN[dSRdXK]dFG1 X[HdRGWdWFSPdFG1
NSIdWFHJdUTUdHI1 NSIdJYMSNHdHI1 NSIdXJ]dHTIJ1 NSIdWJQdIJSTRdHI1
ZSNKIdX[HdHI1 IRTX1 RNQdUJWXdHQFXdHI1 I^dUWHdHRXIdTKK1 HN[dUF^dLWdQ[QdSW1
HN[dUF^dUQFSdHI1 TWLZdSR1 ZSNYdNIJSYdHI1 FYLdUJGI1 GFXI1 GNWYMDIY1
NSIdGWYMDHNY^dSR1 NSIdGWYMDXYFdHI1 NSIdGWYMDHYW^dHI1 HFXdUWTLSTXNXdHI1
MTXUdSR1 MTXUdH^dSR1 MTXUdXY1 MTXUdHYW^1 ILdYJ]Y1 UWTLSTXNXdY]1
INFLSTXNXdY]1 IXGQ^dWJYdQNXyDHI1 RNQdXUdY1 RNQdIWQdY1 NSIdIXGQ^dUHYdSW1
XLQNdY1 HFXdIYMDKfHdY^UdHI1 NSIdMTWdH^dSR1 NSIdMTWdXYdHI1 NSIdMTWdHYW^dHI1
HTSYdMTXU_YsDnsdHI1 TWLFSN_FYNTSdSR1 HFXdNSHSYdYSLdHI1 HFXdNSKdKHdYUdHI1
JRWLdSYKSdW[\dY1 JRWLdSYKSdHTRUQdY1 NSIdIJFYMDIY1 NSIdIYMDMTXUdSR1
NSIdIYMDHNY^dSR1 NSIdIYMDXYFdHI1 NSIdIYMDHYW^dHI1 [JMdT\SIdHI1 [JMdWTQJdHI1
HFXdQTIdNSdWVdHI1 HFXdGJSJdXYFYdHI1 HFXdGJSJdXYdY1 HFXdGJSJdJSIdY1 HFXdY1
TQIdHFXdY1 HFXdHNY^dSR1 HFXdZXdXYFdHI1 HFXdHYW^dHI1 MNLMdRNQdWFSPdFG1
MNLMdRNQdWFSPdJSIdY1 MNLMdRNQdWFSPdXYdY1 WHRIdRNQdWFSPdFG1 UWTRdQXYdY1
HFXdUWTHdNSKTdY]dHNWH1 HFXdUWTHdNSKTdY]dHFZX1 HFXdWRPXdY]1 [JMdLWUdHI1
[JMdHI1 [JMdXZUdHI1 \FWdHTSKQNHYdHI1 TUXdNSHNIJSYdHI1 HFXdJ[JSYdY^UdHI1
WUYdY^UJdHI1 XZUdX[HdHI1 WH[^dXNYJdZYRdSW1 HFXdQFYdQTSL1 HFXdFIWdQTHdY]1
HFXdRJIUWTLdHI1 NSIdHY_UdHYW^dHI1 URTX1 HTSYWdFLJSH^1 WHdYTZWdXYWYdY1
WHdYTZWdHRUQdY1 WHdYTZWdY^UdHI1 HFXdWRdNRdWH[W^dHI1 IHNUXdHFXdNSHSYdSW1
IHNUXdHFXdKFRdRGWdSW1 JINUN . XJQJHY INXYNSHY -XJQJHY RF]-HFXdWUYdNI. 0 6
KWTR IKdHFXZFQY^1 -XJQJHY RF]-HFXdWUYdNI. 0 6 KWTR IKdHFXZFQY^1 ,,1
,MFXy^,1 ,IHNUXK|i,1 ,75775;5=698:,1 ,IHNUXK|i,1 ,75775;5=6>88,1 ,N,1
,[RO77556,1 ,,1 ,,1 ,,1 ,S,1 ,I,1 ,F,1 ,,1 ,,1 ,,1 ,,1 ,,1 ,,1 ,,1 ,,1 ,W,1 ,F,1
,H,1 ,558=75888,1 ,,1 ,Qtxfunt,1 ,Snhmtqfx,1 ,Ujyiw,1 ,,1 ,HFUY,1 ,,1 ,,1
,,1 ,,1 ,R,1 ,,1 ,,1 ,,1 ,,1 ,,1 ,[RR 8;9,1 ,,1 ,,1 ,,1 ,,1 ,,1 ,,1 ,,1
,,1 ,,1 ,,1 ,,1 ,,1 ,,1 ,,1 ,,1 ,,1 ,,1 ,,1 ,,1 ,,1 ,,1 ,,1 ,,1
,,1 ,,1 ,,1 ,75775;5=6755,1 ,,1 ,N[T Mtqy{nqqj,1 ,HF,1 ,ZX,1 ,,1 ,,1 ,,1
,UI^,1 ,,1 ,,1 ,75775;5=6755,1 ,,1 ,Mtqy{nqqj,1 ,HF,1 ,ZX,1 ,,1 ,,1 ,,1 ,,1
,,1 ,Fs R[277 Txuwj~ hwfxfmji |mnqj htsizhynsl ywfnsnsl fy Wfslj27:67 N[T tk
Mtqy{nqqj1 Hfqntwsnf fy fuuwt}nrfyjq~ 6755 ts 75775;5=3,1 ,Ujsnsl,1 ,F
Htrrfis Ns{jxynlfynt |nqq gj nsnyfyji3 XST |fx ijhqfwji ijhxfxi g~
Htrujysy Rjinhfq Fzymtwny~ Rnpj Rnxynwjq1 Nrujwnfq Htwsy~ Htwtsjw -<;5.
88>2;8663 Ymj zсны utnsy tk htsyfhy nx J]jhzynfj Ttknhjw1 [RR28;91 Rfotw
Gwnfs U3 Xuttsjw1 Ttknhj -<;5. <;8269=8 tw gwnfs3u3xuttsjwEzxrh3rnq3 Ymj UHW
[jwnknjw nx Htrrfisnsl Ttknhjw1 [RR28;91 Qnjzyjsfsy Htqtsjq Otms H3 Rnqqjw1
Ttknhj ->59. 7>92757= tw otms3h3rnqqjw9Ezxrh3rnq3,1 ,,1 ,,1 ,,1 ,,1 ,,1
,N,1 ,,1 ,,1 ,,1 ,,1 ,,1 ,,1 ,,1 ,,1 ,,1 ,,1 ,S,1 ,,1 ,,1 ,68>98=889=,
KWTR IKdHFXZFQY^

AIKXVQJSIC

ATWFXVQGJLNSC

NSXJWY NSYT IKdHFXZFQY^ HFXdWUYdNI1 NSNYdHFXdWUYdNI1 FWHMN[J1 HWdZXJWdNI1
HWdIYYR1 QRIdZXJWdNI1 QRIdIYYR1 WUYdY^UdYGI1 HFXdWUYdSW1 HFXdNSNYdWUYdSW1
HFXdHFXJdHQXdIY1 HN[dJRUDY^UJdHI1 HFXdNSHNISYdHI1 HFXdXYFYdFG1 HFXdHFYdHI1
XUhdNSY1 XUhdHFY1 YJWWdFHY1 RZQYdHFXdJ[JSYdHI1 RZQYdHFXdJ[JSYdY]1
UJWXdY^UJdHI1 UJWXdRNQFKQdHI1 UJWXdHFYdHI1 NSIdXXS1 TQIdNSIdXXS1
NSIN[dQFXyDSR1 NSIN[dKNWXYdSR1 NSIN[dRNIIQJdSR1 NSIN[dSRdXK]dFG1
X[HdRGWdWFSPdFG1 NSIdWFHJdUTUdHI1 NSIdJYMSNHdHI1 NSIdXJ]dHTIJ1
NSIdWJQdIJSTRdHI1 ZSNKIdX[HdHI1 IRTX1 RNQdUJWXdHQFXdHI1 I^dUWHdHRXSI dTKK1
HN[dUF^dLWdQ[QdSW1 HN[dUF^dUQFSdHI1 TWLZdSR1 ZSNYdNIJSYdHI1 FYLdUJGI1 GFXI1
GNWYMDIY1 NSIdGWYMDHNY^dSR1 NSIdGWYMDXYFdHI1 NSIdGWYMDHYW^dHI1
HFXdUWTLSTXNXdHI1 MTXUdSR1 MTXUdH^dSR1 MTXUdXY1 MTXUdHYW^1 ILdYJY1
UWTLSTXNXdY]1 INFLSTXNXdY]1 IXGQ^dWJYdQNXyDHI1 RNQdXUdIY1 RNQdIWQdIY1
NSIdIXGQ^dUHYdSW1 XLQNdIY1 HFXdIYMDKFHYd^UdHI1 NSIdMTWdH^dSR1 NSIdMTWdXYdHI1
NSIdMTWdHYW^dHI1 HTSYdMTXU_YSDNSdHI1 TWLFSN_FYNTSdSR1 HFXdNSHSYdYSLdHI1
HFXdNSKdKHdYUdHI1 JRWLdSYKdSdW[\dIY1 JRWLdSYKdSdHTRUQdIY1 NSIdIJFYMDIY1
NSIdIYMDMTXUdSR1 NSIdIYMDHNY^dSR1 NSIdIYMDXYFdHI1 NSIdIYMDHYW^dHI1
[JMdT\SIdHI1 [JMdWTQJdHI1 HFXdQTIdNSdWVdHI1 HFXdGJSJdXYFYdHI1
HFXdGJSJdXYdIY1 HFXdGJSJdSIdIY1 HFXdIY1 TQIdHFXdIY1 HFXdHNY^dSR1
HFXdZXdXYFdHI1 HFXdHYW^dHI1 MNLMdRNQdWFSPdFG1 MNLMdRNQdWFSPdJSIdIY1
MNLMdRNQdWFSPdXYdIY1 WHRIdRNQdWFSPdFG1 UWTRdQXYdIY1 HFXdUWTHdNSKTdY]dHNWH1
HFXdUWTHdNSKTdY]dHFZX1 HFXdWRPXdY]1 [JMdLWUdHI1 [JMdHI1 [JMdXZUdHI1
\FWdHTSKQNHYdHI1 TUXdNSHNISYdHI1 HFXdJ[JSYdY^UdHI1 WUYdY^UJdHI1
XZUdX[HdHI1 WH[^dXNYJdZYRdSW1 HFXdQFYdQTS1 HFXdFIWdQTHdY]1
HFXdRJIUWTLdHI1 NSIdHY_UdHYW^dHI1 URTX1 HTSYWdFLJSH^1 WHdYTZWdXYWYdIY1
WHdYTZWdHRUQdIY1 WHdYTZWdY^UdHI1 HFXdWRdNRdWH[W^dHI1 IHNUXdHFXdNSHSYdSW1
IHNUXdHFXdKFRdRGWdSW1 JINUN . [FQZJX - hfxdwuydni3sj]y{fq1
hfxdwuydni3sj}y{fq1 ,,1 ,IHNUXK|i,1 YTdIFYJ-,5=2ozs27577 698:,1 ,ii2rts2~~~~
mm79?rn,,1 ,IHNUXK|i,1 YTdIFYJ-,5=2ozs27577 6>88,1 ,ii2rts2~~~~ mm79?rn,,1
,N,1 ,[RO77556,1 ,,1 szqq1 ,,1 ,S,1 ,l,1 ,F,1 ,,1 ,,1 ,,1 ,,1 ,W,1 ,F,1
,H,1 ,558=75888,1 ,,1 ,Qtxfunt,1 ,Snhmtqfx,1 ,Ujyjw,1 ,,1 ,HFUY,1 ,,1 ,,1
,,1 ,,1 ,R,1 ,,1 ,,1 ,,1 ,,1 ,,1 ,[RR 8;9,1 ,,1 szqq1 szqq1 szqq1 ,,1 ,,1
,,1 ,,1 ,,1 ,,1 ,,1 ,,1 ,,1 ,,1 ,,1 szqq1 szqq1 ,,1 szqq1 ,l,1 ,,1 ,,1
,,1 ,,1 ,,1 ,,1 ,,1 szqq1 szqq1 YTdIFYJ-,5=2ozs27577 6755,1 ,ii2rts2~~~~
mm79?rn,,1 ,,1 ,N[T Mtqy{nqqj,1 ,HF,1 ,ZX,1 ,,1 ,,1 ,,1 ,UI^,1 szqq1 szqq1
YTdIFYJ-,5=2ozs27577 6755,1 ,ii2rts2~~~~ mm79?rn,,1 szqq1 ,Mtqy{nqqj,1 ,HF,1
,ZX,1 ,,1 szqq1 szqq1 ,,1 szqq1 ,Fs R[277 Txuwj~ hwfmxji |mnqj htsizhynsl
ywfnsnsl fy Wfslj27:67 N[T tk Mtqy{nqqj1 Hfqntwsnf fy fuuwt}nrfyja~ 6755 ts
75775;5=3,1 ,Ujsinsl,1 ,F Htrrfsi Ns[jxynlfynts |nqq gj nsynfyji3 XST |fx
ijhqfwji ijhjfxi g~ Htrujyjsy Rjinhfq Fzymbwny~ Rnpj Rnxywnjq1 Nrujwnfq
Htzsy~ Htwtsjw -<;5. 88>2;8663 Ymj zsn y utnsy tk htsyfhy nx J}jhzyn{j
Tkknhjw1 [RR28;91 Rfotw Gwnfs U3 Xuttsjw1 Tkknhj -<;5. <;8269=8 tw
gwnfs3u3xuttsjwEzxr3rnq3 Ymj UHW [jwnknjw nx Htrrfsinl Tkknhjw1 [RR28;91
Qnjzyjsfsy Htqtsjq Otms H3 Rnqqjw1 Tkknhj ->59. 7>92757= tw
otms3h3rnqqjw9Ezxr3rnq3,1 ,,1 ,,1 ,,1 ,,1 ,,1 ,,1 ,N,1 ,,1 ,,1 ,,1 ,,1
,,1 ,,1 ,,1 szqq1 szqq1 ,,1 ,S,1 ,,1 ,,1 ,68>98=889=.

ATWFXVQSIC

AXVQC

NSXJWY NSYT IHNUXK\I- WUYdY^UdYGI1 HFXdNSHNISYdHI1 HFXdXYFYdFG1 HFXdHFYdHI1
HFXdWUYdSW1 RZQYdHFXdJ[JSYdHI1 RZQYdHFXdJ[JSYdY]1 UJWXdY^UJdHI1
UJWXdRNQFKQdHI1 UJWXdHFYdHI1 NSIdXXS1 TQIdNSIdXXS1 NSIN[dQFXyDSR1
NSIN[dKNWXYdSR1 NSIN[dRNIIQJdSR1 NSIN[dSRdXK]dFG1 NSIdZSNKIdX[HdHI1
X[HdRGWdWFSPdHI1 TWLZdSRJ1 HFXdGJSJdXYFYdHI1 HFXdIY1 TQIdHFXdIY1
HFXdNSKdKHdYUdHI1 HFXdHNY^dSR1 HFXdZXdXYFdHI1 HFXdHYW^dHI1 NSIdIJFYMdiY1
HFXdIYMdKFHdY^UdHI1 NSIdIYMdHNY^dSR1 NSIdIYMdXYFdHI1 NSIdIYMdHYW^dHI1
HFXdWRdNRdWH[W^dHI1 INFLSTXNXdY]1 HFXdUWTHdNSKTdY]dHNWH1
HFXdUWTHdNSKTdY]dHFZX1 HFXdWRPXdY]1 HFXdHFXJdHQXdIYdYGI1 XUFWJ5:1 MTXUdSR1
MTXUdH^dSR1 MTXUdHYW^1 MTXUdXY1 UWTLSTXNXdY]1 HFXdUWTLSTXNXdHIdYGI . [FQZJX
- ,NSNY,1 ,S,1 ,I,1 ,F,1 ,[RO77556,1 ,,1 ,,1 ,W,1 ,F,1 ,H,1 ,558=75888,1 ,,1
,Qtxfunt,1 ,Snhmtqfx,1 ,Ujyiw,1 ,,1 ,R,1 ,HFUY,1 ,[RR 8;9,1 ,UI^,1
,75775;5=6755,1 ,,1 ,,1 ,Mtqy{nqqj,1 ,HF,1 ,ZX,1 ,75775;5=6755,1 ,I,1 ,N[T
Mtqy{nqqj,1 ,HF,1 ,ZX,1 ,S,1 ,,1 ,Fs R[277 Txuwj~ hwfxmji |mnqj htsizhynsl
ywfnsnsl fy Wfslj27:67 N[T tk Mtqy{nqqj1 Hfqnktwsnf fy fuuwt}nrfyjq~ 6755 ts
75775;5=3,1 ,Ujsinsl,1 ,F Htrrsi Ns{jxynlfynts |nqq gj nsynfyji3 XST |fx
ijhqfwji ijhfjxi g~ Htrujyjsy Rjinhfq Fzymtwny~ Rnpj Rnxywnjq1 Nrujwnfq
Htzsy~ Htwtsjw -<;5. 88>2;8663 Ymj zsn y utnsy tk htsyfhy nx J}jhzyn{j
Tkknhjw1 [RR28;91 Rfotw Gwnfs U3 Xuttsjw1 Tkknhj -<;5. <;8269=8 tw
gwnfs3u3xuttsjwEzxr3rnq3 Ymj UHW [jwnknjw nx Htrrsinsl Tkknhjw1 [RR28;91
Qnjzyjsfsy Htqtsjq Otms H3 Rnqqjw1 Tkknhj ->59. 7>92757= tw
otms3h3rnqqjw9Ezxr3rnq3,1 ,,1 ,IHNUXK|i,1 ,,1 ,,1 ,,1 ,,1 ,,1 ,,
AJSIC



UNITED STATES MARINE CORPS
MARINE MEDIUM TILTROTOR SQUADRON 364
MARINE AIRCRAFT GROUP 39
CAMP PENDLETON
PO BOX 555931



Remember OPSEC is everyone's responsibility, keep our information secure!

Wednesday, 8 June, 2022 (22159)

DUTIES	TIMES	KNFG	LPOD	SCHEDULED	SBT	FY
SDO:		AIRFIELD HOURS: 0900-0100	0045	MV-228 20 28.0	JUNE QTR	
SDC:		HOT FUEL: 1100-2300		Total 20 28.0	FCST/ACT	FCST/ACT
DNCO:		COLD FUEL: 0700-2345			260.0/66.5	2368.0/1370.2
ADNCO:		QUIET HOURS: NONE				
ODO:	0530-1200	NITEX: 2101-0100				
	1200-1830					
	1830-LPOD					
SKED:						

KNFG: U (-7)	BMNT: 0436	SR/SS:	0540/1958	EENT: 2102	MR/MS:	1352/0150	ILLUM:	55%	LLL:	0117-0420	HLL:	0420-0436 2102-0153*
--------------	------------	--------	-----------	------------	--------	-----------	--------	-----	------	-----------	------	----------------------

EVENT	TMS	CALLSIGN	BRF/ETD/ETA	ICAO	CREW	FLIGHTS	TBR	TMR	MSN	SBTP	CONFIG	NOTES
7101	MV-228	SWIFT 01	0830/TBA/TBA NET: 0700	KNFG/KNFG			2030 2030 2240	2K2	FCF	0/0.0		
7111	MV-228	SWIFT 11	0600/0800/1330	KNFG/KNFG	SL Capt Losapio Capt Sax Cpl Rasmuson Cpl Carlson LCpl Strickland	2140 2242 2280 2281 2282 2541 2640 6240 6900 2140 2242 2280 2281 2282 2541 2640 6900 2142 2240 2282 2541 2640 6351 6900 2140 2242 2282 2541 2640 5630X,6351 900 2140X,2240X,2242X,2640X	1A1 1A3 1B1	DAY LAT / TG / RVLS / LATI	4/5.0	FUEL: 11.0 2 X GAU-21 1200 RDS .50 CAL	1	
7112	MV-228	SWIFT 12	0600/0800/1330	KNFG/KNFG		2140 2242 2280 2281 2282 2541 2640 6900 2140 2242 2280 2281 2282 2541 2640 6900 2140 2242 2282 2541 2640 6351 6900 2140 2242 2282 2541 2640 5631X 6351 6900 2140X,2240X,2242X,2640X	1A1 1A3 1B1	DAY LAT / TG / RVLS / LATI	4/5.0	FUEL: 11.0 2 X GAU-21 1200 RDS .50 CAL	1	
7121	MV-228	SWIFT 21	1100/1400/1900 NET: 0800	KNFG/KNFG	SL	2242 2280 2281 2282 4140 4580 6240 6900 2242 2280 2281 2282 4140X 4580X 6900 2242 2282 4140 4580 6900 2242 2282 4140 4580 6900	1A9	CALS / RVLS / FASTROPE	3/4.5	FUEL: 11.0 2 X POMMEL	2	
7122	MV-228	SWIFT 22	1100/1400/1900 NET: 0800	KNFG/KNFG		2242 2280 2281 2282 4140 4580 6900 2242 2280 2281 2282 4140X ,6900 2242 2282 4140 4580 6900 2242 2282 4140X,4580X 6900	1A9	CALS / RVLS / FASTROPE	3/4.5	FUEL: 11.0 2 X POMMEL	2	
7131	MV-228	SWIFT 31	1645/1945/0045 NET: 1515	KNFG/KNFG	SL	2280 2281 2282 2341 2543 3441 4083 4840 6240 6900 2280 2281 2282 2341 2543 3441 6900 2280 2281 2282 2341 4083X,4840 6900 2280 2281 2282 2341 4083X,4840 6900 2282 2341 2543 3441 4083 4840 6351 6900 2282 2341 2543 3441 4083X 4840 6350X 6900 2282 2341 6900	1A9	CAT / NS EXTERNALS / HLL CAL / RVLS / NS TG	3/4.5	FUEL: 11.0 2 X GAU-21 1200 RDS .50 CAL 2 X PENDANT	3	
7132	MV-228	SWIFT 32	1645/1945/0045 NET: 1515	KNFG/KNFG		2280 2281 2282 2341 2543 3441 6900 2280 2281 2282 2341 2543 3441 6900 2340X,2543X 2282 2341 2543 3441 6351 6900 2282 2341 2542 6350X 6900	1A9	CAT / NS EXTERNALS / HLL CAL / RVLS / NS TG	3/4.5	FUEL: 11.0 2 X GAU-21 1200 RDS .50 CAL 2 X PENDANT	3	

MAINTENANCE NOTES:

Max A/C: 3
 ST 11/12: 1 B/U
 ST 21/22: 1 B/U if not used by ST 11/12
 ST31/32: 1 B/U if not used by ST 21/22

FLIGHT NOTES:

1. Route: KNFG-VR 1268-Rice-KHII-VR 289-Inkey Barley-KNFG. R-2512 reserved 1200-1300L. Rice deconflicted 0900-1100L. CTO PPR 08-NH-01. Able East reserved 0830-0930L. VR-1268 reserved A-D 1545-1615Z. VR-289 reserved A-E 1815-1845Z.
 2. Route: KNFG-L2 Roadrunner-KNFG.Fastrope with V1/4 in TA Sierra 3. 70 Pax slick. POC:
 3. Route: KNFG-LHD PAD-TALA-KNFG-CACTUS WEST-KNFG. LHD PAD co-use with HMLA-169. KNFG Range 2000-2200L. Whiskey Impact area reserved 2200-2300L. NS External with CLB 15 in TALA. POC TALA reserved 2000-0000L. Flight brief conducted with HMLA-169 on 7 June.

GROUND EVENTS:

START	END	SUBJECT	LOCATION	POC	PERSONNEL	NOTES
0700	0715	FOD WALK	HANGAR		ALL AVAILABLE PERSONNEL	
0700	0715	MAINTENANCE MEETING	MAINTENANCE CONTROL		ALL MAINTENANCE PERSONNEL	
0730	0800	CO STANDUP	CO'S CONFERENCE ROOM			
0900	1100	CRB	MAG-39 CONFERENCE ROOM			
1400	1500	DFT COA DECISION BRIEF	CO'S OFFICE			
1500	1530	SNCO MEETING	READY ROOM		ALL SNCOs	
1600	1615	MAINTENANCE MEETING	MAINTENANCE CONTROL		ALL MAINTENANCE PERSONNEL	

QUESTIONS OF THE DAY

1. EP:
 1. PRTR OVERTORQUE (E2-4-5)
 1. MANEUVER SEVERITY - REDUCE
 2. LAND AS SOON AS PRACTICAL
 NOTE: OVERTORQUES MAY CAUSE TORQUE SENSOR FAIL. PFCS RESET WILL BE REQUIRED TO CLEAR THE SENSOR FAILURES PRIOR TO CLEARING THE PRTR OVERTORQUE.
2. NATOPS: THE _____ ASSEMBLIES ARE DESIGNED TO REDUCE ROTOR-INDUCED 3/REV VIBRATIONS. PENDULUM DAMPENER
3. TACTICS: EXPENDABLES (CHAFF AND FLARE) DISPENSED BY THE AN/ALE-47 COUNTER-MEASURES DISPENSING SYSTEM DECEIVE WHAT TWO ANTI-AIRCRAFT SYSTEMS? RADAR AND INFRARED SENSORS

MAINT /S/ DOSS /S/ OPS /S/ XO /S/

UNCLASSIFIED/
MSGID/GENADMIN/CMC WASHINGTON DC PPO POC//
SUBJ/OPREP-3 SIR/ VMM-364 / 01364 /
REF/A/DOC/CMC/MCO 3504.2_//
REF/B/TEL/ /082148ZJUN22
REF/C/DOC/CMC/OPNAVINST 3750.6_//
NARR/REF A IS MCO ON OPREP-3 SIR: SERIOUS INCIDENT REPORTS. REF B IS VOICE
REPORT MADE TO THE MCOC BY REF C IS THE NAVY INSTRUCTION ON THE
NAVAL AVIATION SAFETY PROGRAM. //
UNIT POC/ /MAJ/OPERATIONS/COMM: /DSN: /EMAIL:
/
POC/1/ /MAJ/EXECUTIVE OFFICER/COMM: /DSN:
/EMAIL: //

GENTEXT/REMARKS/1. DURING A TRAINING FLIGHT, 2 X MV-22B WERE CONDUCTING TAIL
GUNNERY PRACTICE IN THE R-2512 RANGE COMPLEX AT THE INKEY BARLEY TARGET IVO
EL CENTRO, CA. THE -2 AIRCRAFT LOST SIGHT OF THE LEAD AIRCRAFT AND
SUBSEQUENTLY NOTED SMOKE AND DEBRIS EVIDENCE OF A CRASH IN THE VICINITY OF
THE TARGET AREA. THE WINGMAN ASSUMED ON SCENE COMMANDER DUTIES. APPROXIMATELY
900 ROUNDS OF .50 CALIBER AMMUNITION REMAIN ONBOARD AIRCRAFT. LOCAL LAW
ENFORCEMENT IS AWARE AND ON SCENE.

2. 081930ZJUN22 // CONFIRMED 082148ZJUN22
3. R-2512 RANGE COMPLEX, INKEY BARLEY GUN TARGET
4. PERSONNEL INVOLVED

- A. PILOT IN COMMAND
 1. CAPT
 2. LOSAPIO, NICHOLAS, P
 3. / 7532
 4. VMM-364
 5. CAUCASIAN, MALE
- B. CO-PILOT
 1. CAPT
 2. SAX, JOHN, J
 3. / 7532
 4. VMM-364
 5. CAUCASIAN, MALE
- C. CREW CHIEF
 1. CPL
 2. RASMUSON, SETH, D
 3. / 6176
 4. VMM-364
 5. CAUCASIAN, MALE
- D. CREW CHIEF
 1. CPL
 2. CARLSON, NATHAN, E
 3. / 6176
 4. VMM-364
 5. CAUCASIAN, MALE
- E. CREW CHIEF
 1. LCPL
 2. STRICKLAND, EVAN A
 3. / 6176
 4. VMM-364
 5. CAUCASIAN, MALE

5. 3D MAW COMMSTRAT HAS BEEN NOTIFIED. MEDIA INTEREST IS EXPECTED.
6. MAG-39 S-2 HAS BEEN NOTIFIED.

Enclosure (10)

Enclosure (4)

7. LOCAL AUTHORITIES HAVE BEEN NOTIFIED. INCIDENT IS CURRENTLY UNDER INVESTIGATION BY SQUADRON AMB. //

Enclosure (10)

Enclosure (4)



UNITED STATES MARINE CORPS
THIRD MARINE AIRCRAFT WING, FMF
MARINE CORPS AIR STATION MIRAMAR
P.O. BOX 452038
SAN DIEGO, CA 92145-2038

IN REPLY REFER TO
5830

24 Jun 22

From: /8042, USMC
To: Commanding General, 3d Marine Aircraft Wing, FMF
Subj: LINE OF DUTY PRELIMINARY INQUIRY INTO THE DEATH OF CAPTAIN
JOHN J. SAX /7532 USMC
Ref: (a) JAGINST 5800.7G CH-1
Encl: (1) Appointing Order
(2) Personnel Casualty Report dtd 9 June 22
(3) VMM-364 Flight Schedule dtd 8 June 22
(4) OPREP-3 Serious Incident Report dtd 8 Jun 22

1. This reports completion of the preliminary inquiry conducted in accordance with reference (a) into the death of Captain John J. Sax /7532 USMC on 8 June 2022.

2. Personnel contacted:

- a. , USMC, Staff Secretary, 3d Marine Aircraft Wing,
- b. , USMC, Executive Officer, VMM-364,

3. Materials reviewed: Enclosures (1)-(4) were reviewed and all original copies are maintained by the Third Marine Aircraft Wing Office of the Staff Judge Advocate.

4. Summary of findings:

a. Paragraph 0215 of the reference states that a death incurred by a Marine on active duty is presumed to be "in the line of duty." This presumption can only be overcome by "clear and convincing" evidence that certain circumstances existed at the time of death.

b. On 08 June 2022 Captain Sax was on active duty in the United States Marine Corps, assigned to Marine Medium Tiltrotor Squadron 364 (VMM-364), Marine Aircraft Group 39 (MAG-39), 3d Marine Aircraft Wing (3d MAW), enclosure (2).

c. The Commanding Officer, VMM-364, MAG-39, 3d MAW, authorized a rear mounted weapon system (RMWS) training mission comprised of two Marine Medium Tiltrotor (MV-22B) aircraft in the R-2512 range complex near El Centro, California on 08 June 2022, enclosures (3) and (4). Captain Sax was a member of the flight crew of the aircraft identified as Swift 11 in enclosure (3).

Enclosure (11)

Subj: LINE OF DUTY PRELIMINARY INQUIRY INTO THE DEATH OF CAPTAIN
JOHN J. SAX /7532 USMC

d. Prior to the launch of the mission, the flight crews were briefed on the mission and conditions, and an Operational Risk Management assessment was conducted to ensure the safety of all personnel associated with the mission.

e. At approximately 1230 hours on 8 June 2022 Swift 12 lost sight of Swift 11. The pilot and crew from Swift 12 noted smoke and, upon closer inspection, evidence of a crash by Swift 11 in the R-2512 range complex in the vicinity of El Centro, CA. Enclosure (4).

f. The Imperial County Coroner's Office pronounced all pilots and crew of Swift 11 dead on 8 June 2022. Enclosure (2).

g. There is no evidence indicating any misconduct, intoxication or drug abuse in this case.

5. Recommendation: I recommend that Captain John J. Sax be found to have died in the line of duty and not due to the member's own misconduct.

Controlled by: Department of the Navy
Controlled by: OSJA, 3d MAW (USMC)

POC: SJA, 3d MAW



UNITED STATES MARINE CORPS,

THIRD MARINE AIRCRAFT WING, FMF
MARINE CORPS AIR STATION MIRAMAR
P.O. BOX 452038
SAN DIEGO CA 92145-2038

IN REPLY REFER TO:
5830
OSJA
13 Jun 22

From: Commanding General, 3d Marine Aircraft Wing, FMF
To: USMC

Subj: COMMAND INVESTIGATION INTO THE CLASS A AVIATION MISHAP THAT
OCCURRED ON 08 JUNE 2022 IN THE R-2512 RANGE COMPLEX

Ref: (a) 10 U.S. Code, Section 2255
(b) JAGINST 5800.7G w/CH I (JAGMAN)

1. This Command Investigation (CI) is convened to investigate the circumstances surrounding a Class A aviation mishap in compliance with reference (a).
2. This letter appoints you in accordance with the references to investigate the cause and responsibility for the subject aviation mishap, the fatalities, description of all damage to property, and any attendant circumstances.
3. You are to complete both a line of duty determination Preliminary Inquiry (PI) and a Class A aviation mishap CI. Chapter II, Appendix A-2-k, and Appendix A-2-n of reference (b) are your governing reference materials. Templates for your PI and CI can be found at Appendix A-2-c and A-2-e, respectively.
 - a. You shall report your PI in writing by 14 calendar days from the date of this letter. If you require additional time, you shall submit a written request for such with detailed justification for any delay. Any request for extension shall be submitted via the 3d Marine Aircraft Wing's (3d MAW) Staff Judge Advocate (SJA). The request and associated response shall be included in your report.
 - b. You shall report your CI in writing by 60 calendar days from the date of this letter. If you require additional time, you shall submit a written request for such with detailed justification for the delay. Any request for extension shall be submitted via the 3d MAW SJA. The request and associated response shall be included in your report.
4. This is your primary duty until your PI and CI reports are completed, unless otherwise relieved of such duty by competent authority. Requests for additional support in your investigative efforts shall be submitted via the 3d MAW Chief of Staff. You are granted direct liaison authority with the senior member of the Aviation Mishap Board and with Naval Air Systems Command for requests related to this mishap.
5. You shall consult with the 3d MAW Director of Safety and Standardization and SJA on the conduct of your line of duty PI and aviation mishap CI.

Enclosure (11)

Enclosure (1)

Subj: COMMAND INVESTIGATION INTO THE CLASS A AVIATION MISHAP THAT OCCURRED ON 08 JUNE 2022 IN THE R-2512 RANGE COMPLEX

6. By copy to: of this order, _____ are appointed as your assistant investigating officers, unless otherwise relieved of such duties by competent authority, to provide technical expertise on investigations.

7. The point of contact for this matter is the 3d MAW SJA, _____ at _____

Copy to:
CO, MAG-39
CO. VMM-364

From:
Sent: Wednesday, June 8, 2022 7:44 PM
To: Casualty PCR USMC - Deceased
Cc:

Subject: 3MAW G-1 CASUALTY
) Casualty Report - INIT - Sax, John - Incident Date/Time: 2022/06/08 12:00
Attachments: Sax_John_INIT_6-8-2022.rsf
Signed By:

***** CASUALTY REPORT *****

Report Type: INIT
Casualty Type: Nonhostile
Casualty Status: DECEASED
Casualty Category: Accident
Report Number: VMJ22002
Personnel Type: Regular
Personnel Affiliation: Active Duty
Personnel Category: Obligated/Voluntary Service
Last Name: Sax
First Name: John
Middle Name: Jeremy

Service: United States Marine Corps

Military Rank: CAPT

Military Unit of Assignment: VMM 364

Date/Time of Incident (New/Old): 20220608/1200

Incident City: Holtville

Incident State: CA

Incident Country: United States

Circumstance: An MV-22 Osprey crashed while conducting training at Range-2512 IVO of Holtville, California at approximately 1200 on 20220608.

Died in/out of Medical Facility Treatment: Died Outside A Medical Treatment Facility

Date/Time of Death: 20220608/1200

Place of Death City: IVO Holtville

Place of Death State: CA

Place of Death Country: United States

Cause of Death: Pending

Duty Status: Present For Duty

Remarks: A Command Investigation will be initiated. SNO was declared deceased by Competent Medical Authority

VMM-364, The unit point of contact is Executive Officer, , Office or . The PCR Verifier is Commanding Officer, VMM-364, , Office or

Software Version: DCIPS Forward - Version 8.0 Build: 70 Release Date: 01 May 2014

AIK95XVQXJHYNTSC

AIKXVQGJLNSC

NSXJWY NSYT IKdHFXZFQY^ - HFXdWUYdNI1 NSNYdHFXdWUYdNI1 FWHMN[J1 HWJFYJidKWTR1
HWdZXJWdNI1 HWdiYR1 QRidZXJWdNI1 QRidYR1 WUYdY^UdYGI1 HFXdWUYdSW1
HFXdNSNYdWUYdSW1 HFXdHFXJdHQXdY1 HN[dJRudY^UJdHI1 HFXdNSHNISYdHI1
HFXdXYFYdFG1 HFXdHFYdHI1 XUHdNSY1 XUHdHFY1 YJWWdFHY1 HFXdUW[XdXYFYdHI1
HFXdUW[XdHFYdHI1 RZQYdHFXdJ[JSYdHI1 RZQYdHFXdJ[JSYdY]1 UJWXdY^UJdHI1
UJWXdRNQFKQdHI1 UJWXdHFYdHI1 NSIdXXS1 TQIdNSIdXXS1 NSIN[dQFXyDSR1
NSIN[dKNWXYdSR1 NSIN[dRNIIQJdSR1 NSIN[dSRdXK]dFG1 X[HdRGWdWFSPdFG1
NSIdWFHJdUTUdHI1 NSIdJYMSNHdHI1 NSIdXJ]dHTIJ1 NSIdWJQdIJSTRdHI1
ZSNKIdX[HdHI1 IRTX1 RNQdUJWXdHQFXdHI1 I^dUWHdHRXSIdTKK1 HN[dUF^dLWdQ[QdSW1
HN[dUF^dUQFSdHI1 TWLZdSR1 ZSNYdNIJSYdHI1 FYLdUJGI1 GFXI1 GNWYMDIY1
NSIdGWYMDHNY^dSR1 NSIdGWYMDXYFdHI1 NSIdGWYMDHYW^dHI1 HFXdUWTLSTXNXdHI1
MTXUdSR1 MTXUdH^dSR1 MTXUdXY1 MTXUdHYW^1 ILdYJ]Y1 UWTLSTXNXdY]1
INFLSTXNXdY]1 IXGQ^dWJYdQNXyDHI1 RNQdXUdY1 RNQdIWQdY1 NSIdIXGQ^dUHYdSW1
XLQNdY1 HFXdIYMDKFHYdY^UdHI1 NSIdMTWdH^dSR1 NSIdMTWdXYdHI1 NSIdMTWdHYW^dHI1
HTSYdMTXU_YSdNSdHI1 TWLFSN_FYNTSdSR1 HFXdNSHSYdYSLdHI1 HFXdNSKdKHdYUdHI1
JRWLdSYKSdW[\dY1 JRWLdSYKSdHTRUQdY1 NSIdIJFYMDIY1 NSIdIYMDMTXUdSR1
NSIdIYMDHNY^dSR1 NSIdIYMDXYFdHI1 NSIdIYMDHYW^dHI1 [JMdT\SIdHI1 [JMdWTQJdHI1
HFXdQTIdNSdWVdHI1 HFXdGJSJdXYFYdHI1 HFXdGJSJdXYdY1 HFXdGJSJdJSIdY1 HFXdY1
TQIdHFXdY1 HFXdHNY^dSR1 HFXdZXdXYFdHI1 HFXdHYW^dHI1 MNLMdRNQdWFSPdFG1
MNLMdRNQdWFSPdJSIdY1 MNLMdRNQdWFSPdXYdY1 WHRIdRNQdWFSPdFG1 UWTRdQXYdY1
HFXdUWTHdNSKTdY]dHNWH1 HFXdUWTHdNSKTdY]dHFZX1 HFXdWRPXdY]1 [JMdLWUdHI1
[JMdHI1 [JMdXZUdHI1 \FwDHTSKQNHdHI1 TUXdNSHNISYdHI1 HFXdJ[JSYdY^UdHI1
WUYdY^UJdHI1 XZUdX[HdHI1 WH[^dXNYJdZYRdSW1 HFXdQFYdQTS1 HFXdFIWdQTHdY]1
HFXdRJIdUWTLdHI1 NSIdHY_UdHYW^dHI1 URTX1 HTSYdFLJSH^1 WHdYTZWdXYWYdY1
WHdYTZWdHRUQdY1 WHdYTZWdY^UdHI1 HFXdWRdNRdWH[W^dHI1 IHNUXdHFXdNSHSYdSW1
IHNUXdHFXdKFRdRGWdSW1 JINUN . XJQJHY INXYNSHY -XJQJHY RF]-HFXdWUYdNI. 0 6
KWTR IKdHFXZFQY^ .1 -XJQJHY RF]-HFXdWUYdNI. 0 6 KWTR IKdHFXZFQY^ .1 ,,1
,MFXy^,1 ,IHNUXK|i,1 ,75775;5=6:99,1 ,IHNUXK|i,1 ,75775;5=6>88,1 ,N,1
,[RO77557,1 ,,1 ,,1 ,,1 ,S,1 ,l,1 ,F,1 ,,1 ,,1 ,,1 ,,1 ,,1 ,,1 ,,1 ,,1 ,W,1 ,F,1
,H,1 ,,6<95>=6<,1 ,,1 ,Xf,1 ,Otms,1 ,Ojwjr~,1 ,,1 ,HFUY,1 ,,1 ,,1 ,,1 ,,1
,R,1 ,,1 ,,1 ,,1 ,,1 ,,1 ,[RR 8;9,1 ,,1 ,,1 ,,1 ,,1 ,,1 ,,1 ,,1 ,,1 ,,1
,,1 ,,1 ,,1 ,,1 ,,1 ,,1 ,,1 ,,1 ,,1 ,l,1 ,,1 ,,1 ,,1 ,,1 ,,1 ,,1 ,,1
,,1 ,75775;5=6755,1 ,,1 ,N[T Mtqy{nqqj,1 ,HF,1 ,ZX,1 ,,1 ,,1 ,,1 ,UI^,1 ,,1
,,1 ,75775;5=6755,1 ,,1 ,Mtqy{nqqj,1 ,HF,1 ,ZX,1 ,,1 ,,1 ,,1 ,,1 ,,1 ,Fs
R[277 Txuwj~ hwfmxji |mnqj htsizhynsl ywfnsnsl fy Wfslj27:67 N[T tk
Mtqy{nqqj1 Hfqntksnf fy fuuwt}nrfyjq~ 6755 ts 75775;5=3,1 ,Ujsinsl,1 ,F
Htrrfsi Ns{jxynlfynts |nqq gj nsnyfyji3 XST |fx ijhqfwji ijhfxji g~
Htrujyjsy Rjinhfq Fzymtwny~ Rnpj Rnxynwj1 Nrujwnfq Htzy~ Htwtsjw -<;5.
88>2;8663 Ymj zsyn utnsy tk htsyfy nx J}jhzyn{j Tkknhjw1 [RR28;91 Rfotw
Gwnfs U3 Xuttsjw1 Tkknhj -<;5. <;8269=8 tw gwnfs3u3xuttsjwEzxr3rnq3 Ymj UHW
[jwnknjw nx Htrrfsinl Tkknhjw1 [RR28;91 Qnjzyjsfsy Htqtsjq Otms H3 Rnqqjw1
Tkknhj ->59. 7>92757= tw otms3h3rnqqjw9Ezxr3rnq3,1 ,,1 ,,1 ,,1 ,,1 ,,1 ,,1
,N,1 ,,1 ,,1 ,,1 ,,1 ,,1 ,,1 ,,1 ,,1 ,,1 ,,1 ,,1 ,S,1 ,,1 ,,1 ,6:58>>>>=,
KWTR IKdHFXZFQY^

AIKXVQJSIC

ATWFXVQGJLNSC

NSXJWY NSYT IKdHFXZFQY^- HFXdWUYdNI1 NSNYdHFXdWUYdNI1 FWHMN[J1 HWdZXJWdNI1
HWdiYYR1 QRidZXJWdNI1 QRIdiYYR1 WUYdY^UdYGI1 HFXdWUYdSW1 HFXdNSNYdWUYdSW1
HFXdHFXJdHQXdIY1 HN[dJRUDY^UJdHI1 HFXdNSHNISYdHI1 HFXdXYFYdFG1 HFXdHFYdHI1
XUHdNSY1 XUHdHFY1 YJWWdFHY1 RZQYdHFXdJ[JSYdHI1 RZQYdHFXdJ[JSYdY]1
UJWXdY^UJdHI1 UJWXdRNQFKQdHI1 UJWXdHFYdHI1 NSIdXXS1 TQIdNSIdXXS1
NSIN[dQFXyDSR1 NSIN[dKNWXYdSR1 NSIN[dRNIIQJdSR1 NSIN[dSRdXK]dFG1
X[HdRGWdWFSPdFG1 NSIdWFHJdUTUdHI1 NSIdJYMSNHdHI1 NSIdXJ]dHTIJ1
NSIdWJQdIJSTRdHI1 ZSNKIdX[HdHI1 IRTX1 RNQdUJWXdHQFXdHI1 I^dUWHdHRXSIDTKK1
HN[dUF^dLWdQ[QdSW1 HN[dUF^dUQFSdHI1 TWLZdSRJ1 ZSNYdNIJSYdHI1 FYLdUJGI1 GFXI1
GNWYMDIY1 NSIdGWYMDHNY^dSR1 NSIdGWYMDXYFdHI1 NSIdGWYMDHYW^dHI1
HFXdUWTLSTXNXdHI1 MTXUdSR1 MTXUdH^dSR1 MTXUdXY1 MTXUdHYW^1 ILdYJ]Y1
UWTLSTXNXdY]1 INFLSTXNXdY]1 IXGQ^dWJYdQNXyDHI1 RNQdXUdIY1 RNQdIWQdIY1
NSIdIXGQ^dUHdYdSW1 XLQNdIY1 HFXdIYMDKFHY^UdHI1 NSIdMTWdH^dSR1 NSIdMTWdXYdHI1
NSIdMTWdHYW^dHI1 HTSYdMTXU_YSdNSdHI1 TWLFSN_FYNTSdSR1 HFXdNSHSYdYSLdHI1
HFXdNSKdKHdYUdHI1 JRWLdSYKdW[\dIY1 JRWLdSYKdHTRUQdIY1 NSIdIJFYMDIY1
NSIdIYMDMTXUdSR1 NSIdIYMDHNY^dSR1 NSIdIYMDXYFdHI1 NSIdIYMDHYW^dHI1
[JMdT\SIdHI1 [JMdWTQJdHI1 HFXdQTIdNSdWVdHI1 HFXdGJSJdXYFYdHI1
HFXdGJSJdXYdIY1 HFXdGJSJdSIdIY1 HFXdIY1 TQIdHFXdIY1 HFXdHNY^dSR1
HFXdZXdXYFdHI1 HFXdHYW^dHI1 MNLMdRNQdWFSPdFG1 MNLMdRNQdWFSPdJSIdIY1
MNLMdRNQdWFSPdXYdIY1 WHRIdRNQdWFSPdFG1 UWTRdQXYdIY1 HFXdUWTHdNSKTdY]dHNWH1
HFXdUWTHdNSKTdY]dHFZX1 HFXdWRPXdY]1 [JMdLWUdHI1 [JMdHI1 [JMdXZUUdHI1
\FWdHTSKQNHYdHI1 TUXdNSHNISYdHI1 HFXdJ[JSYdY^UdHI1 WUYdY^UJdHI1
XZUUdX[HdHI1 WH[^dXNYJdZYRdSW1 HFXdQFYdQTS1 HFXdFIWdQTHdY]1
HFXdRJIdUWTLdHI1 NSIdHY_UdHYW^dHI1 URTX1 HTSYWdFLJSH^1 WHdYTZWdXYWYdIY1
WHdYTZWdHRUQdIY1 WHdYTZWdY^UdHI1 HFXdWRdNRdWH[W^dHI1 IHNUXdHFXdNSHSYdSW1
IHNUXdHFXdKFRdRGWdSW1 JINUN . [FQZJX - hfxdwuydni3sj}y{fq1
hfxdwuydni3sj}y{fq1 ,,1 ,IHNUXK|i,1 YTdIFYJ-,5=2ozs27577 6:99,1 ,ii2rts2~~~~
mm79?rn,,1 ,IHNUXK|i,1 YTdIFYJ-,5=2ozs27577 6>88,1 ,ii2rts2~~~~ mm79?rn,,1
,N,1 ,[RO77557,1 ,,1 szqq1 ,,1 ,S,1 ,l,1 ,F,1 ,,1 ,,1 ,,1 ,,1 ,,1 ,W,1 ,F,1
,H,1 ,;6<95>=6<,1 ,,1 ,Xf,1 ,Otms,1 ,Ojwjr~,1 ,,1 ,HFUY,1 ,,1 ,,1 ,,1 ,,1
,R,1 ,,1 ,,1 ,,1 ,,1 ,,1 ,[RR 8;9,1 ,,1 szqq1 szqq1 szqq1 ,,1 ,,1 ,,1
,,1 ,,1 ,,1 ,,1 ,,1 ,,1 ,,1 szqq1 szqq1 ,,1 szqq1 ,l,1 ,,1 ,,1 ,,1
,,1 ,,1 ,,1 szqq1 szqq1 YTdIFYJ-,5=2ozs27577 6755,1 ,ii2rts2~~~~ mm79?rn,,1
,,1 ,N[T Mtqy{nqqj,1 ,HF,1 ,ZX,1 ,,1 ,,1 ,,1 ,UI^,1 szqq1 szqq1
YTdIFYJ-,5=2ozs27577 6755,1 ,ii2rts2~~~~ mm79?rn,,1 szqq1 ,Mtqy{nqqj,1 ,HF,1
,ZX,1 ,,1 szqq1 szqq1 ,,1 szqq1 ,Fs R[277 Txuwj~ hwfxmji |mnqj htsizhynsl
ywfnsnsl fy Wfslj27:67 N[T tk Mtqy{nqqj1 Hfqnktsnf fy fuuwt}nrffyq~ 6755 ts
75775;5=3,1 ,Ujsinsl,1 ,F Htrrfsi Ns{jxynlfynts |nqq gj nsynfyji3 XST |fx
ijhqfwji ijhjfxi g~ Htrujyjsy Rjinhfq Fzymbwny~ Rnpj Rnxywnjq1 Nrujwnfq
Htzy~ Htwtsjw -<;5. 88>2;8663 Ymj zsn y utnsy tk htsyfhy nx J}jhzyn{j
Tkknhjw1 [RR28;91 Rfotw Gwnfs U3 Xuttsjw1 Tkknhj -<;5. <;8269=8 tw
gwnfs3u3xuttsjwEzxr3rnq3 Ymj UHW [jwnknjw nx Htrrfsinl Tkknhjw1 [RR28;91
Qnjzysfsy Htqtsjq Otms H3 Rnqqjw1 Tkknhj ->59. 7>92757= tw
otms3h3rnqqjw9Ezxr3rnq3,1 ,,1 ,,1 ,,1 ,,1 ,,1 ,,1 ,N,1 ,,1 ,,1 ,,1 ,,1
,,1 ,,1 ,,1 szqq1 szqq1 ,,1 ,S,1 ,,1 ,,1 ,6:58>>>>=,.

ATWFXVQJSIC

AXVQC

NSXJWY NSYT IHNUXK\I- WUYdY^UdYGI1 HFXdNSHNISYdHI1 HFXdXYFYdFG1 HFXdHFYdHI1
HFXdWUYdSW1 RZQYdHFXdJ[JSYdHI1 RZQYdHFXdJ[JSYdY]1 UJWXdY^UJdHI1
UJWXdRNQFKQdHI1 UJWXdHFYdHI1 NSIdXXS1 TQIdNSIdXXS1 NSIN[dQFXYdSR1
NSIN[dKNWXYdSR1 NSIN[dRNIIQJdSR1 NSIN[dSRdXK]dFG1 NSIdZSNKIdX[HdHI1
X[HdRGWdWFSPdHI1 TWLZdSRJ1 HFXdGJSJdXYFYdHI1 HFXdIY1 TQIdHFXdIY1
HFXdNSKdKHdYUdHI1 HFXdHNY^dSR1 HFXdZXdXYFdHI1 HFXdHYW^dHI1 NSIdIJFYMdIY1
HFXdIYMdKFHdY^UdHI1 NSIdIYMdHNY^dSR1 NSIdIYMdXYFdHI1 NSIdIYMdHYW^dHI1
HFXdWRdNRdWH[W^dHI1 INFLSTXNXdY]1 HFXdUWTHdNSKTdY]dHNWH1
HFXdUWTHdNSKTdY]dHFZX1 HFXdWRPXdY]1 HFXdHFJdHQXdIYdYGI1 XUFWJ5:1 MTXUdSR1
MTXUdH^dSR1 MTXUdHYW^1 MTXUdXY1 UWTLSTXNXdY]1 HFXdUWTLSTXNXdHIdYGI . [FQZJX
- ,NSNY,1 ,S,1 ,I,1 ,F,1 ,[RO77557,1 ,,1 ,,1 ,W,1 ,F,1 ,H,1 ,,6<95>=6<,1 ,,1
,Xf},1 ,Otms,1 ,Ojwj~ ,1 ,,1 ,R,1 ,HFUY,1 ,[RR 8;9,1 ,UI^,1 ,75775;5=6755,1
,,1 ,,1 ,Mtqy{nqqj,1 ,HF,1 ,ZX,1 ,75775;5=6755,1 ,I,1 ,N[T Mtqy{nqqj,1 ,HF,1
,ZX,1 ,S,1 ,,1 ,Fs R[277 Txuwj~ hwfxmji |mnqj htsizhynsl ywfnsnsl fy
Wfslj27:67 N[T tk Mtqy{nqqj1 Hfqnktsnf fy fuuwt}nrfyjq~ 6755 ts 75775;5=3,1
,Ujsinsl,1 ,F Htrrfsi Ns{jxynlfynts |nqq gj nsynfyji3 XST |fx ijhqfwji
ijhjfxji g~ Htrujyjsy Rjinhfq Fzymbwny~ Rnpj Rnxywnjq1 Nrujwnfq Htzsy~
Htwtsjw -<;5. 88>2;8663 Ymj zsny utnsy tk htsyfhy nx J}jhzyn{j Tkknhjw1
[RR28;91 Rfotw Gwnfs U3 Xuttsjw1 Tkknhj -<;5. <;8269=8 tw
gwnfs3u3xuttsjwEzxrh3rnq3 Ymj UHW [jwnknjw nx Htrrfinsl Tkknhjw1 [RR28;91
Qnzyjsfsy Htqtsjq Otms H3 Rnqqjw1 Tkknhj ->59. 7>92757= tw
otms3h3rnqqjw9Ezxrh3rnq3,1 ,,1 ,IHNUXK|i,1 ,,1 ,,1 ,,1 ,,1 ,,1 ,,1 ,,1
AJSIC



UNITED STATES MARINE CORPS
MARINE MEDIUM TILTROTOR SQUADRON 364
MARINE AIRCRAFT GROUP 39
CAMP PENDLETON
PO BOX 555931



Remember OPSEC is everyone's responsibility, keep our information secure!

Wednesday, 8 June, 2022 (22159)

DDO:	KNFG	LPOD	SCHEDULED	SBT	FY
SDO:	AIRFIELD HOURS: 0900-0100	0045	MV-228 20 28.0	QTR	
DNCO:	HOT FUEL: 1100-2300		Total 20 28.0	FCST/ACT	FCST/ACT
ADNCO:	COLD FUEL: 0700-2345			260.0/66.5	2368.0/1370.2
ODO:	QUILT HOURS: NONE				
	NITEX: 2101-0100				
SKED:	0530-1200				
	1200-1830				
	1830-LPOD				

KNFG: U (-7)	BMNT: 0436	SR/SS: 0540/1958	EENT: 2102	MR/MS: 1352/0150	ILLUM: 55%	LLL: 0117-0420	HLL: 0420-0436 2102-0153*
--------------	------------	------------------	------------	------------------	------------	----------------	---------------------------

EVENT	TMS	CALLSIGN	BRF/ETD/ETA	ICAO	CREW	FLIGHTS	TMR	MSN	SBTP	CONFIG	NOTES
7101	MV-228	SWIFT 01	0830/TBA/TBA NET: 0700	KNFG/KNFG			2030 2030 2240	FCF	0/0.0		
7111	MV-228	SWIFT 11	0600/0800/1330	KNFG/KNFG	SL Capt Losapio Capt Sax Cpl Rasmuson Cpl Carlson LCpl Strickland	2140 2242 2280 2281 2282 2541 2640 6240 6900 2140 2242 2280 2281 2282 2541 2640 6900 2142 2240 2282 2541 2640 6351 6900 2140 2242 2282 2541 2640 5630X,6351 900 2140X,2240X,2242X,2640X	1A1 1A3 1B1	DAY LAT / TG / RVLS / LATI	4/5.0	FUEL: 11.0 2 X GAU-21 1200 RDS .50 CAL	1
7112	MV-228	SWIFT 12	0600/0800/1330	KNFG/KNFG		2140 2242 2280 2281 2282 2541 2640 6900 2140 2242 2280 2281 2282 2541 2640 6900 2140 2242 2282 2541 2640 6351 6900 2140 2242 2282 2541 2640 5631X 6351 6900 2140X,2240X,2242X,2640X	1A1 1A3 1B1	DAY LAT / TG / RVLS / LATI	4/5.0	FUEL: 11.0 2 X GAU-21 1200 RDS .50 CAL	1
7121	MV-228	SWIFT 21	1100/1400/1900 NET: 0800	KNFG/KNFG	SL	2242 2280 2281 2282 4140 4580 6240 6900 2242 2280 2281 2282 4140X 4580X 6900 2242 2282 4140 4580 6900 2242 2282 4140 4580 6900	1A9	CALS / RVLS / FASTROPE	3/4.5	FUEL: 11.0 2 X POMMEL	2
7122	MV-228	SWIFT 22	1100/1400/1900 NET: 0800	KNFG/KNFG		2242 2280 2281 2282 4140 4580 6900 2242 2280 2281 2282 4140X ,6900 2242 2282 4140 4580 6900 2242 2282 4140X,4580X 6900	1A9	CALS / RVLS / FASTROPE	3/4.5	FUEL: 11.0 2 X POMMEL	2
7131	MV-228	SWIFT 31	1645/1945/0045 NET: 1515	KNFG/KNFG	SL	2280 2281 2282 2341 2543 3441 4083 4840 6240 6900 2280 2281 2282 2341 2543 3441 6900 2280 2281 2282 2341 4083X,4840 6900 2280 2281 2282 2341 4083X,4840 6900 2282 2341 2543 3441 4083 4840 6351 6900 2282 2341 2543 3441 4083X 4840 6350X 6900 2282 2341 6900	1A9	CAT / NS EXTERNALS / HLL CAL / RVLS / NS TG	3/4.5	FUEL: 11.0 2 X GAU-21 1200 RDS .50 CAL 2 X PENDANT	3
7132	MV-228	SWIFT 32	1645/1945/0045 NET: 1515	KNFG/KNFG		2280 2281 2282 2341 2543 3441 6900 2280 2281 2282 2341 2543 3441 6900 2340X,2543X 2282 2341 2543 3441 6351 6900 2282 2341 2542 6350X 6900	1A9	CAT / NS EXTERNALS / HLL CAL / RVLS / NS TG	3/4.5	FUEL: 11.0 2 X GAU-21 1200 RDS .50 CAL 2 X PENDANT	3

MAINTENANCE NOTES:

Max A/C: 3
 ST 11/12: 1 B/U
 ST 21/22: 1 B/U if not used by ST 11/12
 ST 31/32: 1 B/U if not used by ST 21/22

FLIGHT NOTES:

1. Route: KNFG-VR 1268-Rice-KHII-VR 289-Inkey Barley-KNFG. R-2512 reserved 1200-1300L. Rice deconflicted 0900-1100L. CTO PPR 08-NH-01. Able East reserved 0830-0930L. VR-1268 reserved A-D 1545-1615Z. VR-289 reserved A-E 1815-1845Z.
 2. Route: KNFG-L2 Roadrunner-KNFG.Fastrope with V1/4 in TA Sierra 3. 70 Pax slick. POC
 3. Route: KNFG-LHD PAD-TALA-KNFG-CACTUS WEST-KNFG. LHD PAD co-use with HMLA-169. KNFG Range 2000-2200L. Whiskey Impact area reserved 2200-2300L. NS External with CLB 15 in TALA. POC TALA reserved 2000-0000L. Flight brief conducted with HMLA-169 on 7 June.

GROUND EVENTS:

START	END	SUBJECT	LOCATION	POC	PERSONNEL	NOTES
0700	0715	FOD WALK	HANGAR		ALL AVAILABLE PERSONNEL	
0700	0715	MAINTENANCE MEETING	MAINTENANCE CONTROL		ALL MAINTENANCE PERSONNEL	
0730	0800	CO STANDUP	CO'S CONFERENCE ROOM			
0900	1100	CRB	MAG-39 CONFERENCE ROOM			
1400	1500	DFT COA DECISION BRIEF	CO'S OFFICE			
1500	1530	SNCO MEETING	READY ROOM		ALL SNCOs	
1600	1615	MAINTENANCE MEETING	MAINTENANCE CONTROL		ALL MAINTENANCE PERSONNEL	

QUESTIONS OF THE DAY

1. EP:
 1. PRTR OVERTORQUE (E2-4-5)
 1. MANEUVER SEVERITY - REDUCE
 2. LAND AS SOON AS PRACTICAL
 NOTE: OVERTORQUES MAY CAUSE TORQUE SENSOR FAIL. PFCS RESET WILL BE REQUIRED TO CLEAR THE SENSOR FAILURES PRIOR TO CLEARING THE PRTR OVERTORQUE.
2. NATOPS: THE _____ ASSEMBLIES ARE DESIGNED TO REDUCE ROTOR-INDUCED 3/REV VIBRATIONS. PENDULUM DAMPENER
3. TACTICS: EXPENDABLES (CHAFF AND FLARE) DISPENSED BY THE AN/ALE-47 COUNTER-MEASURES DISPENSING SYSTEM DECEIVE WHAT TWO ANTI-AIRCRAFT SYSTEMS? RADAR AND INFRARED SENSORS

MAINT /s/ DOSS /s/ OPS /s/ XO /s/

UNCLASSIFIED/
MSGID/GENADMIN/CMC WASHINGTON DC PPO POC//
SUBJ/OPREP-3 SIR/ VMM-364 / 01364 /
REF/A/DOC/CMC/MCO 3504.2_//
REF/B/TEL/ /082148ZJUN22
REF/C/DOC/CMC/OPNAVINST 3750.6_//
NARR/REF A IS MCO ON OPREP-3 SIR: SERIOUS INCIDENT REPORTS. REF B IS VOICE
REPORT MADE TO THE MCOC BY REF C IS THE NAVY INSTRUCTION ON THE
NAVAL AVIATION SAFETY PROGRAM. //
UNIT POC/ MAJ/OPERATIONS/COMM: /DSN: /EMAIL:
//
POC/1/ /MAJ/EXECUTIVE OFFICER/COMM: /DSN:
EMAIL: //

GENTEXT/REMARKS/1. DURING A TRAINING FLIGHT, 2 X MV-22B WERE CONDUCTING TAIL
GUNNERY PRACTICE IN THE R-2512 RANGE COMPLEX AT THE INKEY BARLEY TARGET IVO
EL CENTRO, CA. THE -2 AIRCRAFT LOST SIGHT OF THE LEAD AIRCRAFT AND
SUBSEQUENTLY NOTED SMOKE AND DEBRIS EVIDENCE OF A CRASH IN THE VICINITY OF
THE TARGET AREA. THE WINGMAN ASSUMED ON SCENE COMMANDER DUTIES. APPROXIMATELY
900 ROUNDS OF .50 CALIBER AMMUNITION REMAIN ONBOARD AIRCRAFT. LOCAL LAW
ENFORCEMENT IS AWARE AND ON SCENE.

- 2. 081930ZJUN22 // CONFIRMED 082148ZJUN22
- 3. R-2512 RANGE COMPLEX, INKEY BARLEY GUN TARGET
- 4. PERSONNEL INVOLVED

- A. PILOT IN COMMAND
 - 1. CAPT
 - 2. LOSAPIO, NICHOLAS, P
 - 3. / 7532
 - 4. VMM-364
 - 5. CAUCASIAN, MALE
- B. CO-PILOT
 - 1. CAPT
 - 2. SAX, JOHN, J
 - 3. / 7532
 - 4. VMM-364
 - 5. CAUCASIAN, MALE
- C. CREW CHIEF
 - 1. CPL
 - 2. RASMUSON, SETH, D
 - 3. / 6176
 - 4. VMM-364
 - 5. CAUCASIAN, MALE
- D. CREW CHIEF
 - 1. CPL
 - 2. CARLSON, NATHAN, E
 - 3. / 6176
 - 4. VMM-364
 - 5. CAUCASIAN, MALE
- E. CREW CHIEF
 - 1. LCPL
 - 2. STRICKLAND, EVAN, A
 - 3. / 6176
 - 4. VMM-364
 - 5. CAUCASIAN, MALE

- 5. 3D MAW COMMSTRAT HAS BEEN NOTIFIED. MEDIA INTEREST IS EXPECTED.
- 6. MAG-39 S-2 HAS BEEN NOTIFIED.

Enclosure (11)

Enclosure (4)

7. LOCAL AUTHORITIES HAVE BEEN NOTIFIED. INCIDENT IS CURRENTLY UNDER INVESTIGATION BY SQUADRON AMB. //

Enclosure (11)

Enclosure (4)



UNITED STATES MARINE CORPS
THIRD MARINE AIRCRAFT WING, FMF
MARINE CORPS AIR STATION MIRAMAR
P.O. BOX 452038
SAN DIEGO, CA 92145-2038

IN REPLY REFER TO
5830

24 Jun 22

From: /8042, USMC
To: Commanding General, 3d Marine Aircraft Wing, FMF
Subj: LINE OF DUTY PRELIMINARY INQUIRY INTO THE DEATH OF CORPORAL
SETH D. RASMUSON 6176 USMC
Ref: (a) JAGINST 5800.7G CH-1
Encl: (1) Appointing Order
(2) Personnel Casualty Report dtd 9 June 22
(3) VMM-364 Flight Schedule dtd 8 June 22
(4) OPREP-3 Serious Incident Report dtd 8 Jun 22

1. This reports completion of the preliminary inquiry conducted in accordance with reference (a) into the death of Corporal Seth D. Rasmuson /6176 USMC on 8 June 2022.

2. Personnel contacted:

- a. , USMC, Staff Secretary, 3d Marine Aircraft Wing,
- b. , USMC, Executive Officer, VMM-364,

3. Materials reviewed: Enclosures (1)-(4) were reviewed and all original copies are maintained by the Third Marine Aircraft Wing Office of the Staff Judge Advocate.

4. Summary of findings:

a. Paragraph 0215 of the reference states that a death incurred by a Marine on active duty is presumed to be “in the line of duty.” This presumption can only be overcome by “clear and convincing” evidence that certain circumstances existed at the time of death.

b. On 08 June 2022 Corporal Rasmuson was on active duty in the United States Marine Corps, assigned to Marine Medium Tiltrotor Squadron 364 (VMM-364), Marine Aircraft Group 39 (MAG-39), 3d Marine Aircraft Wing (3d MAW), enclosure (2).

c. The Commanding Officer, VMM-364, MAG-39, 3d MAW, authorized a rear mounted weapon system (RMWS) training mission comprised of two Marine Medium Tiltrotor (MV-22B) aircraft in the R-2512 range complex near El Centro, California on 08 June 2022, enclosures (3) and (4). Corporal Rasmuson was a member of the flight crew of the aircraft identified as Swift 11 in enclosure (3).

Enclosure (12)

Subj: LINE OF DUTY PRELIMINARY INQUIRY INTO THE DEATH OF CORPORAL
SETH D. RASMUSON /6176 USMC

d. Prior to the launch of the mission, the flight crews were briefed on the mission and conditions, and an Operational Risk Management assessment was conducted to ensure the safety of all personnel associated with the mission.

e. At approximately 1230 hours on 8 June 2022 Swift 12 lost sight of Swift 11. The pilot and crew from Swift 12 noted smoke and, upon closer inspection, evidence of a crash by Swift 11 in the R-2512 range complex in the vicinity of El Centro, CA. Enclosure (4).

f. The Imperial County Coroner's Office pronounced all pilots and crew of Swift 11 dead on 8 June 2022. Enclosure (2).

g. There is no evidence indicating any misconduct, intoxication or drug abuse in this case.

5. Recommendation: I recommend that Corporal Seth D. Rasmuson be found to have died in the line of duty and not due to the member's own misconduct.

Controlled by: Department of the Navy
Controlled by: OSJA, 3d MAW (USMC)

POC: SJA, 3d MAW



UNITED STATES MARINE CORPS,

THIRD MARINE AIRCRAFT WING, FMF
MARINE CORPS AIR STATION MIRAMAR
P.O. BOX 452038
SAN DIEGO CA 92145-2038

IN REPLY REFER TO:
5830
OSJA
13 Jun 22

From: Commanding General, 3d Marine Aircraft Wing, FMF
To: USMC

Subj: COMMAND INVESTIGATION INTO THE CLASS A AVIATION MISHAP THAT
OCCURRED ON 08 JUNE 2022 IN THE R-2512 RANGE COMPLEX

Ref: (a) 10 U.S. Code, Section 2255
(b) JAGINST 5800.7G w/CH 1 (JAGMAN)

1. This Command Investigation (CI) is convened to investigate the circumstances surrounding a Class A aviation mishap in compliance with reference (a).
2. This letter appoints you in accordance with the references to investigate the cause and responsibility for the subject aviation mishap, the fatalities, description of all damage to property, and any attendant circumstances.
3. You are to complete both a line of duty determination Preliminary Inquiry (PI) and a Class A aviation mishap CI. Chapter II, Appendix A-2-k, and Appendix A-2-n of reference (b) are your governing reference materials. Templates for your PI and CI can be found at Appendix A-2-c and A-2-e, respectively.
 - a. You shall report your PI in writing by 14 calendar days from the date of this letter. If you require additional time, you shall submit a written request for such with detailed justification for any delay. Any request for extension shall be submitted via the 3d Marine Aircraft Wing's (3d MAW) Staff Judge Advocate (SJA). The request and associated response shall be included in your report.
 - b. You shall report your CI in writing by 60 calendar days from the date of this letter. If you require additional time, you shall submit a written request for such with detailed justification for the delay. Any request for extension shall be submitted via the 3d MAW SJA. The request and associated response shall be included in your report.
4. This is your primary duty until your PI and CI reports are completed, unless otherwise relieved of such duty by competent authority. Requests for additional support in your investigative efforts shall be submitted via the 3d MAW Chief of Staff. You are granted direct liaison authority with the senior member of the Aviation Mishap Board and with Naval Air Systems Command for requests related to this mishap.
5. You shall consult with the 3d MAW Director of Safety and Standardization and SJA on the conduct of your line of duty PI and aviation mishap CI.

Enclosure (12)

Enclosure (1)

Subj: COMMAND INVESTIGATION INTO THE CLASS A AVIATION MISHAP THAT OCCURRED ON 08 JUNE 2022 IN THE R-2512 RANGE COMPLEX

6. By copy to: of this order, _____ are appointed as your assistant investigating officers, unless otherwise relieved of such duties by competent authority, to provide technical expertise on investigations.

7. The point of contact for this matter is the 3d MAW SJA, _____ at _____

Copy to:
CO, MAG-39
CO. VMM-364

From:
Sent: Wednesday, June 8, 2022 7:44 PM
To: Casualty PCR USMC - Deceased
Cc:

3MAW G-1 CASUALTY

Subject: Casualty Report - INIT - Rasmuson, Seth - Incident Date/Time: 2022/06/08 12:00
Attachments: Rasmuson_Seth_INIT_6-8-2022.rsfc
Signed By:

***** CASUALTY REPORT *****

Report Type: INIT
Casualty Type: Nonhostile
Casualty Status: DECEASED
Casualty Category: Accident
Report Number: VMJ22003
Personnel Type: Regular
Personnel Affiliation: Active Duty
Personnel Category: Obligated/Voluntary Service
Last Name: Rasmuson
First Name: Seth
Middle Name: Dean

Service: United States Marine Corps

Military Rank: CPL

Military Unit of Assignment: VMM 364

Date/Time of Incident (New/Old): 20220608/1200

Incident City: Holtville

Incident State: CA

Incident Country: United States

Circumstance: An MV-22 Osprey crashed while conducting training at Range-2512 IVO of Holtville, California at approximately 1200 on 20220608.

Died in/out of Medical Facility Treatment: Died Outside A Medical Treatment Facility

Date/Time of Death: 20220608/1200

Place of Death City: IVO Holtville

Place of Death State: CA

Place of Death Country: United States

Cause of Death: Pending

Duty Status: Present For Duty

Remarks: A Command Investigation will be initiated. SNM was declared deceased by Imperial County Coroner (760) 339 VMM-364, The unit point of contact is Executive Officer, , Office or The PCR Verifier is Commanding Officer, VMM-364, , Office or

Software Version: DCIPS Forward - Version 8.0 Build: 70 Release Date: 01 May 2014

AIK95XVQXJHYNTSC

AIKXVQGJLNSC

NSXJWY NSYT IKdHFXZFQY^ - HFXdWUYdNI1 NSNYdHFXdWUYdNI1 FWHMN[J1 HWJFYJidKWTR1
HWdZXJWdNI1 HWdiYR1 QRidZXJWdNI1 QRidYR1 WUYdY^UdYGI1 HFXdWUYdSW1
HFXdNSNYdWUYdSW1 HFXdHFXJdHQXdY1 HN[dJRudY^UJdHI1 HFXdNSHNISYdHI1
HFXdXYFYdFG1 HFXdHFYdHI1 XUHdNSY1 XUHdHFY1 YJWWdFHY1 HFXdUW[XdXYFYdHI1
HFXdUW[XdHFYdHI1 RZQYdHFXdJ[JSYdHI1 RZQYdHFXdJ[JSYdY]1 UJWXdY^UJdHI1
UJWXdRNQFKQdHI1 UJWXdHFYdHI1 NSidXXS1 TQIdNSidXXS1 NSIN[dQFXyDSR1
NSIN[dKNWXYdSR1 NSIN[dRNIIQJdSR1 NSIN[dSRdXK]dFG1 X[HdRGWdWFSPdFG1
NSidWFHJdUTUdHI1 NSidJYMSNHdHI1 NSidXJ]dHTIJ1 NSidWJQdIJSTRdHI1
ZSNKIdX[HdHI1 IRTX1 RNQdUJWXdHQFXdHI1 I^dUWHdHRXSidTKK1 HN[dUF^dLWdQ[QdSW1
HN[dUF^dUQFSdHI1 TWLZdSR1 ZSNYdNIJSYdHI1 FYLdUJGI1 GFXI1 GNWYMDIY1
NSidGWYMDHNY^dSR1 NSidGWYMDXYFdHI1 NSidGWYMDHYW^dHI1 HFXdUWTLSTXNXdHI1
MTXUdSR1 MTXUdH^dSR1 MTXUdXY1 MTXUdHYW^1 ILdY]Y1 UWTLSTXNXdY]1
INFLSTXNXdY]1 IXGQ^dWJYdQNXyDHI1 RNQdXUdY1 RNQdIWQdY1 NSidIXGQ^dUHYdSW1
XLQNdY1 HFXdiYMDKFHY^UdHI1 NSidMTWdH^dSR1 NSidMTWdXYdHI1 NSidMTWdHYW^dHI1
HTSYdMTXU_YSdNSdHI1 TWLFSN_FYNTSdSR1 HFXdNSHSYdYSLdHI1 HFXdNSKdKHdYUdHI1
JRWLdSYKSdW[\dY1 JRWLdSYKSdHTRUQdY1 NSidIJFYMDIY1 NSidIYMDMTXUdSR1
NSidIYMDHNY^dSR1 NSidIYMDXYFdHI1 NSidIYMDHYW^dHI1 [JMdT\SidHI1 [JMdWTQJdHI1
HFXdQTidNSdWVdHI1 HFXdGJSJdXYFYdHI1 HFXdGJSJdXYdY1 HFXdGJSJdJSidY1 HFXdY1
TQIdHFXdY1 HFXdHNY^dSR1 HFXdZXdXYFdHI1 HFXdHYW^dHI1 MNLMdRNQdWFSPdFG1
MNLMdRNQdWFSPdJSidY1 MNLMdRNQdWFSPdXYdY1 WHRIdRNQdWFSPdFG1 UWTRdQXYdY1
HFXdUWTHdNSKTdY]dHNWH1 HFXdUWTHdNSKTdY]dHFZX1 HFXdWRPXdY]1 [JMdLWUdHI1
[JMdHI1 [JMdXZUdHI1 \FwDHTSKQNHdHI1 TUXdNSHNISYdHI1 HFXdJ[JSYdY^UdHI1
WUYdY^UJdHI1 XZUdX[HdHI1 WH[^dXNYJdZYRdSW1 HFXdQFYdQTS1 HFXdFIWdQTHdY]1
HFXdRJIdUWTLdHI1 NSidHY_UdHYW^dHI1 URTX1 HTSYdFLJSH^1 WHdYTZWdXYWYdY1
WHdYTZWdHRUQdY1 WHdYTZWdY^UdHI1 HFXdWRdNRdWH[W^dHI1 IHNUXdHFXdNSHSYdSW1
IHNUXdHFXdKFRdRGWdSW1 JINUN . XJQHJY INXYNSHY -XJQHJY RF]-HFXdWUYdNI. 0 6
KWTR IKdHFXZFQY^ .1 -XJQHJY RF]-HFXdWUYdNI. 0 6 KWTR IKdHFXZFQY^ .1 ,,1
,MFXy^,1 ,IHNUXK|i,1 ,75775;5=6::8,1 ,IHNUXK|i,1 ,75775;5=6>8,,1 ,N,1
,[RO77558,1 ,,1 ,,1 ,S,1 ,l,1 ,F,1 ,,1 ,,1 ,,1 ,,1 ,,1 ,,1 ,,1 ,W,1 ,F,1
,H,1 ,:5986=8>6,1 ,,1 ,Wfxrzxts,1 ,Xjym,1 ,ljfs,1 ,,1 ,HUQ,1 ,,1 ,,1 ,,1 ,,1
,R,1 ,,1 ,,1 ,,1 ,,1 ,,1 ,[RR 8;9,1 ,,1 ,,1 ,,1 ,,1 ,,1 ,,1 ,,1 ,,1 ,,1
,,1 ,,1 ,,1 ,,1 ,,1 ,,1 ,,1 ,,1 ,l,1 ,,1 ,,1 ,,1 ,,1 ,,1 ,,1 ,,1
,,1 ,75775;5=6755,1 ,,1 ,N[T Mtqy{nqqj,1 ,HF,1 ,ZX,1 ,,1 ,,1 ,,1 ,UI^,1 ,,1
,,1 ,75775;5=6755,1 ,,1 ,Mtqy{nqqj,1 ,HF,1 ,ZX,1 ,,1 ,,1 ,,1 ,,1 ,Fs
R[277 Txuwj~ hwxmj |mnqj htsizhynsl ywfnsnsl fy Wfslj27:67 N[T tk
Mtqy{nqqj Hfqntksnf fy fuuwt}nrfyjq~ 6755 ts 75775;5=3,1 ,Ujsinsl,1 ,F
Htrrfsi Ns{jxynlfynts |nqq gj nsnyfyji3 XSR |fx ijhqfwji ijhfxji g~
Htrujyjsy Rjinhfq Fzymtwny~ Rnpj Rnxynwj1 Nrujwnfq Htzsy~ Htwtsjw -<;5.
88>2;8663 Ymj zsn y utnsy tk htsyfy nx J}jhzyn{j Tkknhjw1 [RR28;91 Rfotw
Gwnfs U3 Xuttsjw1 Tkknhj -<;5. <;8269=8 tw gwnfs3u3xuttsjwEzxr3rnq3 Ymj UHW
[jwnknjw nx Htrrfsinl Tkknhjw1 [RR28;91 Qnjzyjsfsy Htqtsjq Otms H3 Rnqqjw1
Tkknhj ->59. 7>92757= tw otms3h3rnqqjw9Ezxr3rnq3,1 ,,1 ,,1 ,,1 ,,1 ,,1
,N,1 ,,1 ,,1 ,,1 ,,1 ,,1 ,,1 ,,1 ,,1 ,,1 ,,1 ,S,1 ,,1 ,,1 ,6::568;;,
KWTR IKdHFXZFQY^

AIKXVQJSIC

ATWFXVQGJLNSC

NSXJWY NSYT IKdHFXZFQY^- HFXdWUYdNI1 NSNYdHFXdWUYdNI1 FWHMN[J1 HWdZXJWdNI1
HWdiYYR1 QRidZXJWdNI1 QRIdiYYR1 WUYdY^UdYGI1 HFXdWUYdSW1 HFXdNSNYdWUYdSW1
HFXdHFXJdHQXdIY1 HN[dJRUDY^UJdHI1 HFXdNSHNISYdHI1 HFXdXYFYdFG1 HFXdHFYdHI1
XUHdNSY1 XUHdHFY1 YJWWdFHY1 RZQYdHFXdJ[JSYdHI1 RZQYdHFXdJ[JSYdY]1
UJWXdY^UJdHI1 UJWXdRNQFKQdHI1 UJWXdHFYdHI1 NSIdXXS1 TQIdNSIdXXS1
NSIN[dQFXyDSR1 NSIN[dKNWXYdSR1 NSIN[dRNIIQJdSR1 NSIN[dSRdXK]dFG1
X[HdRGWdWFSPdFG1 NSIdWFHJdUTUdHI1 NSIdJYMSNHdHI1 NSIdXJ]dHTIJ1
NSIdWJQdIJSTRdHI1 ZSNKIdX[HdHI1 IRTX1 RNQdUJWXdHQFXdHI1 I^dUWHdHRXSIDTKK1
HN[dUF^dLWdQ[QdSW1 HN[dUF^dUQFSdHI1 TWLZdSRJ1 ZSNYdNIJSYdHI1 FYLdUJGI1 GFXI1
GNWYMDIY1 NSIdGWYMDHNY^dSR1 NSIdGWYMDXYFdHI1 NSIdGWYMDHYW^dHI1
HFXdUWTLSTXNXdHI1 MTXUdSR1 MTXUdH^dSR1 MTXUdXY1 MTXUdHYW^1 ILdYJ]Y1
UWTLSTXNXdY]1 INFLSTXNXdY]1 IXGQ^dWJYdQNXyDHI1 RNQdXUdIY1 RNQdIWQdIY1
NSIdIXGQ^dUHdYdSW1 XLQNdIY1 HFXdIYMDKFHY^UdHI1 NSIdMTWdH^dSR1 NSIdMTWdXYdHI1
NSIdMTWdHYW^dHI1 HTSYdMTXU_YSdNSdHI1 TWLFSN_FYNTSdSR1 HFXdNSHSYdYSLdHI1
HFXdNSKdKHdYUdHI1 JRWLdSYKdW[\dIY1 JRWLdSYKdHTRUQdIY1 NSIdIJFYMDIY1
NSIdIYMDMTXUdSR1 NSIdIYMDHNY^dSR1 NSIdIYMDXYFdHI1 NSIdIYMDHYW^dHI1
[JMdT\SIdHI1 [JMdWTQJdHI1 HFXdQTIdNSdWVdHI1 HFXdGJSJdXYFYdHI1
HFXdGJSJdXYdIY1 HFXdGJSJdSIdIY1 HFXdIY1 TQIdHFXdIY1 HFXdHNY^dSR1
HFXdZXdXYFdHI1 HFXdHYW^dHI1 MNLMdRNQdWFSPdFG1 MNLMdRNQdWFSPdJSIdIY1
MNLMdRNQdWFSPdXYdIY1 WHRIdRNQdWFSPdFG1 UWTRdQXYdIY1 HFXdUWTHdNSKTdY]dHNWH1
HFXdUWTHdNSKTdY]dHFZX1 HFXdWRPXdY]1 [JMdLWUdHI1 [JMdHI1 [JMdXZUUdHI1
\FWdHTSKQNHYdHI1 TUXdNSHNISYdHI1 HFXdJ[JSYdY^UdHI1 WUYdY^UJdHI1
XZUUdX[HdHI1 WH[^dXNYJdZYRdSW1 HFXdQFYdQTS1 HFXdFIWdQThdY]1
HFXdRJIdUWTLdHI1 NSIdHY_UdHYW^dHI1 URTX1 HTSYWdFLJSH^1 WHdYTZWdXYWYdIY1
WHdYTZWdHRUQdIY1 WHdYTZWdY^UdHI1 HFXdWRdNRdWH[W^dHI1 IHNUXdHFXdNSHSYdSW1
IHNUXdHFXdKFRdRGWdSW1 JINUN . [FQZJX - hfxdwuydni3sj}y{fq1
hfxdwuydni3sj}y{fq1 ,,1 ,IHNUXK|i,1 YTdIFYJ-,5=2ozs27577 6::8,1 ,ii2rts2~~~~
mm79?rn,,1 ,IHNUXK|i,1 YTdIFYJ-,5=2ozs27577 6>8;,1 ,ii2rts2~~~~ mm79?rn,,1
,N,1 ,[RO77558,1 ,,1 szqq1 ,,1 ,S,1 ,l,1 ,F,1 ,,1 ,,1 ,,1 ,,1 ,,1 ,W,1 ,F,1
,H,1 ,:5986=8>6,1 ,,1 ,Wfzxzts,1 ,Xjym,1 ,ljfs,1 ,,1 ,HUQ,1 ,,1 ,,1 ,,1 ,,1
,R,1 ,,1 ,,1 ,,1 ,,1 ,,1 ,[RR 8;9,1 ,,1 szqq1 szqq1 szqq1 ,,1 ,,1 ,,1
,,1 ,,1 ,,1 ,,1 ,,1 ,,1 ,,1 szqq1 szqq1 ,,1 szqq1 ,l,1 ,,1 ,,1 ,,1
,,1 ,,1 ,,1 szqq1 szqq1 YTdIFYJ-,5=2ozs27577 6755,1 ,ii2rts2~~~~ mm79?rn,,1
,,1 ,N[T Mtqy{nqqj,1 ,HF,1 ,ZX,1 ,,1 ,,1 ,,1 ,UI^,1 szqq1 szqq1
YTdIFYJ-,5=2ozs27577 6755,1 ,ii2rts2~~~~ mm79?rn,,1 szqq1 ,Mtqy{nqqj,1 ,HF,1
,ZX,1 ,,1 szqq1 szqq1 ,,1 szqq1 ,Fs R[277 Txuwj~ hwfxmji |mnqj htsizhynsl
ywfnsnsl fy Wfslj27:67 N[T tk Mtqy{nqqj1 Hfqnktsnf fy fuuwt}nrftyjq~ 6755 ts
75775;5=3,1 ,Ujsinsl,1 ,F Htrrfsi Ns{yxynlfynts |nqq gj nsynfyji3 XSR |fx
ijhqfwji ijhfjxi g~ Htrujyjsy Rjinhfq Fzymtwny~ Rnpj Rnxywnjq1 Nrujwnfq
Htzy~ Htwtsjw -<;5. 88>2;8663 Ymj zsn y utnsy tk htsyfhy nx J}jhzyn{
Tkknhjw1 [RR28;91 Rfotw Gwnfs U3 Xuttsjw1 Tkknhj -<;5. <;8269=8 tw
gwnfs3u3xuttsjwEzxr3rnq3 Ymj UHW [jwnknjw nx Htrrfsinl Tkknhjw1 [RR28;91
Qnjzysfsy Htqtsjq Otms H3 Rnqqjw1 Tkknhj ->59. 7>92757= tw
otms3h3rnqqjw9Ezxr3rnq3,1 ,,1 ,,1 ,,1 ,,1 ,,1 ,,1 ,N,1 ,,1 ,,1 ,,1 ,,1
,,1 ,,1 ,,1 szqq1 szqq1 ,,1 ,S,1 ,,1 ,,1 ,6::568;7;,,

ATWFXVQJSIC

AXVQC

NSXJWY NSYT IHNUXK\|- WUYdY^UdYGI1 HFXdNSHNISYdHI1 HFXdXYFYdFG1 HFXdHFYdHI1
HFXdWUYdSW1 RZQYdHFXdJ[JSYdHI1 RZQYdHFXdJ[JSYdY]1 UJWXdY^UJdHI1
UJWXdRNQFKQdHI1 UJWXdHFYdHI1 NSIdXXS1 TQIdNSIdXXS1 NSIN[dQFXyDSR1
NSIN[dKNWXYdSR1 NSIN[dRNIIQJdSR1 NSIN[dSRdXK]dFG1 NSIdZSNKIdX[HdHI1
X[HdRGWdWFSPdHI1 TWLZdSRJ1 HFXdGJSJdXYFYdHI1 HFXdIY1 TQIdHFXdIY1
HFXdNSKdKHdYUdHI1 HFXdHNY^dSR1 HFXdZXdXYFdHI1 HFXdHYW^dHI1 NSIdIJFYMdY1
HFXdIYMdKFHdY^UdHI1 NSIdIYMdHNY^dSR1 NSIdIYMdXYFdHI1 NSIdIYMdHYW^dHI1
HFXdWRdNRdWH[W^dHI1 INFLSTXNXdY]1 HFXdUWTHdNSKTdY]dHNWH1
HFXdUWTHdNSKTdY]dHFZX1 HFXdWRPXdY]1 HFXdHFJdHQXdYdYGI1 XUFWJ5:1 MTXUdSR1
MTXUdH^dSR1 MTXUdHYW^1 MTXUdXY1 UWTLSTXNXdY]1 HFXdUWTLSTXNXdHIdYGI . [FQZJX
- ,NSNY,1 ,S,1 ,I,1 ,F,1 ,[RO77558,1 ,,1 ,,1 ,W,1 ,F,1 ,H,1 ,:5986=8>6,1 ,,1
,Wfxrxzts,1 ,Xjym,1 ,ljfs,1 ,,1 ,R,1 ,HUQ,1 ,[RR 8;9,1 ,UI^,1
,75775;5=6755,1 ,,1 ,,1 ,Mtqy{nqqj,1 ,HF,1 ,ZX,1 ,75775;5=6755,1 ,I,1 ,N[T
Mtqy{nqqj,1 ,HF,1 ,ZX,1 ,S,1 ,,1 ,Fs R[277 Txuwj~ hwfxmji |mnqj htsizhynsl
ywfnsnsl fy Wfslj27:67 N[T tk Mtqy{nqqj1 Hfqnktsnf fy fuuwt}nrfyjq~ 6755 ts
75775;5=3,1 ,Ujsinsl,1 ,F Htrrfsi Ns{jxynlfynts |nqq gj nsynfyji3 XSR |fx
ijhqfwji ijhfjxi g~ Htrujyjsy Rjinhfq Fzymtwny~ Rnpj Rnxywnjq1 Nrujwnfq
Htzy~ Htwtsjw -<;5. 88>2;8663 Ymj zsnv utnsy tk htsyfhy nx J}jhzyn{j
Tkknhjw1 [RR28;91 Rfotw Gwnfs U3 Xuttsjw1 Tkknhj -<;5. <;8269=8 tw
gwnfs3u3xuttsjwEzxrh3rnq3 Ymj UHW [jwnknjw nx Htrrfinsl Tkknhjw1 [RR28;91
Qnzyjsfsy Htqtsjq Otms H3 Rnqqjw1 Tkknhj ->59. 7>92757= tw
otms3h3rnqqjw9Ezxrh3rnq3,1 ,,1 ,IHNUXK|i,1 ,,1 ,,1 ,,1 ,,1 ,,1 ,,1 ,,
AJSIC



UNITED STATES MARINE CORPS
 MARINE MEDIUM TILTROTOR SQUADRON 364
 MARINE AIRCRAFT GROUP 39
 CAMP PENDLETON
 PO BOX 555931



Remember OPSEC is everyone's responsibility, keep our information secure!

Wednesday, 8 June, 2022 (22159)

DUTIES	TIMES	KNFG	LPOD	SCHEDULED	SBT	FY
SDO:		AIRFIELD HOURS: 0900-0100	0045	MV-228 20 28.0	JUNE QTR	
SDC:		HOT FUEL: 1100-2300		Total 20 28.0	FCST/ACT	FCST/ACT
DNCO:		COLD FUEL: 0700-2345			260.0/66.5	2368.0/1370.2
ADNCO:		QUIET HOURS: NONE				
ODO:	0530-1200	NITEX: 2101-0100				
	1200-1830					
	1830-LPOD					
SKED:						

KNFG: U (-7)	BMNT:	0436	SR/SS:	0540/1958	EENT:	2102	MR/MS:	1352/0150	ILLUM:	55%	LLL:	0117-0420	HLL:	0420-0436 2102-0153*
--------------	-------	------	--------	-----------	-------	------	--------	-----------	--------	-----	------	-----------	------	----------------------

EVENT	TMS	CALLSIGN	BRF/ETD/ETA	ICAO	CREW	FLIGHTS	TBR	TMR	MSN	SBTP	CONFIG	NOTES
7101	MV-228	SWIFT 01	0830/TBA/TBA NET: 0700	KNFG/KNFG			2030 2030 2240	2K2	FCF	0/0.0		
7111	MV-228	SWIFT 11	0600/0800/1330	KNFG/KNFG	SL Capt Losapio Capt Sax Cpl Rasmuson Cpl Carlson LCpl Strickland	2140 2242 2280 2281 2282 2541 2640 6240 6900 2140 2242 2280 2281 2282 2541 2640 6900 2142 2240 2282 2541 2640 6351 6900 2140 2242 2282 2541 2640 5630X,6351 900 2140X,2240X,2242X,2640X	1A1 1A3 1B1	DAY LAT / TG / RVLS / LATI	4/5.0	FUEL: 11.0 2 X GAU-21 1200 RDS .50 CAL	1	
7112	MV-228	SWIFT 12	0600/0800/1330	KNFG/KNFG		2140 2242 2280 2281 2282 2541 2640 6900 2140 2242 2280 2281 2282 2541 2640 6900 2140 2242 2282 2541 2640 6351 6900 2140 2242 2282 2541 2640 5631X 6351 6900 2140X,2240X,2242X,2640X	1A1 1A3 1B1	DAY LAT / TG / RVLS / LATI	4/5.0	FUEL: 11.0 2 X GAU-21 1200 RDS .50 CAL	1	
7121	MV-228	SWIFT 21	1100/1400/1900 NET: 0800	KNFG/KNFG	SL	2242 2280 2281 2282 4140 4580 6240 6900 2242 2280 2281 2282 4140X 4580X 6900 2242 2282 4140 4580 6900 2242 2282 4140 4580 6900	1A9	CALS / RVLS / FASTROPE	3/4.5	FUEL: 11.0 2 X POMMEL	2	
7122	MV-228	SWIFT 22	1100/1400/1900 NET: 0800	KNFG/KNFG		2242 2280 2281 2282 4140 4580 6900 2242 2280 2281 2282 4140X ,6900 2242 2282 4140 4580 6900 2242 2282 4140X,4580X 6900	1A9	CALS / RVLS / FASTROPE	3/4.5	FUEL: 11.0 2 X POMMEL	2	
7131	MV-228	SWIFT 31	1645/1945/0045 NET: 1515	KNFG/KNFG	SL	2280 2281 2282 2341 2543 3441 4083 4840 6240 6900 2280 2281 2282 2341 2543 3441 6900 2280 2281 2282 2341 4083X,4840 6900 2280 2281 2282 2341 4083X,4840 6900 2282 2341 2543 3441 4083 4840 6351 6900 2282 2341 2543 3441 4083X 4840 6350X 6900 2282 2341 6900	1A9	CAT / NS EXTERNALS / HLL CAL / RVLS / NS TG	3/4.5	FUEL: 11.0 2 X GAU-21 1200 RDS .50 CAL 2 X PENDANT	3	
7132	MV-228	SWIFT 32	1645/1945/0045 NET: 1515	KNFG/KNFG		2280 2281 2282 2341 2543 3441 6900 2280 2281 2282 2341 2543 3441 6900 2340X,2543X 2282 2341 2543 3441 6351 6900 2282 2341 2542 6350X 6900	1A9	CAT / NS EXTERNALS / HLL CAL / RVLS / NS TG	3/4.5	FUEL: 11.0 2 X GAU-21 1200 RDS .50 CAL 2 X PENDANT	3	

MAINTENANCE NOTES:

Max A/C: 3
 ST 11/12: 1 B/U
 ST 21/22: 1 B/U if not used by ST 11/12
 ST31/32: 1 B/U if not used by ST 21/22

FLIGHT NOTES:

1. Route: KNFG-VR 1268-Rice-KHII-VR 289-Inkey Barley-KNFG. R-2512 reserved 1200-1300L. Rice deconflicted 0900-1100L. CTO PPR 08-NH-01. Able East reserved 0830-0930L. VR-1268 reserved A-D 1545-1615Z. VR-289 reserved A-E 1815-1845Z.
 2. Route: KNFG-L2 Roadrunner-KNFG.Fastrope with V1/4 in TA Sierra 3. 70 Pax slick. POC
 3. Route: KNFG-LHD PAD-TALA-KNFG-CACTUS WEST-KNFG. LHD PAD co-use with HMLA-169. KNFG Range 2000-2200L. Whiskey Impact area reserved 2200-2300L. NS External with CLB 15 in TALA. POC . TALA reserved 2000-0000L. Flight brief conducted with HMLA-169 on 7 June.

GROUND EVENTS:

START	END	SUBJECT	LOCATION	POC	PERSONNEL	NOTES
0700	0715	FOD WALK	HANGAR		ALL AVAILABLE PERSONNEL	
0700	0715	MAINTENANCE MEETING	MAINTENANCE CONTROL		ALL MAINTENANCE PERSONNEL	
0730	0800	CO STANDUP	CO'S CONFERENCE ROOM			
0900	1100	CRB	MAG-39 CONFERENCE ROOM			
1400	1500	DFT COA DECISION BRIEF	CO'S OFFICE			
1500	1530	SNCO MEETING	READY ROOM		ALL SNCOs	
1600	1615	MAINTENANCE MEETING	MAINTENANCE CONTROL		ALL MAINTENANCE PERSONNEL	

QUESTIONS OF THE DAY

1. EP:
 - PRTR OVERTORQUE (E2-4-5)
 - MANEUVER SEVERITY - REDUCE
 - LAND AS SOON AS PRACTICAL
 NOTE: OVERTORQUES MAY CAUSE TORQUE SENSOR FAIL. PFCS RESET WILL BE REQUIRED TO CLEAR THE SENSOR FAILURES PRIOR TO CLEARING THE PRTR OVERTORQUE.
2. NATOPS: THE _____ ASSEMBLIES ARE DESIGNED TO REDUCE ROTOR-INDUCED 3/REV VIBRATIONS. PENDULUM DAMPENER
3. TACTICS: EXPENDABLES (CHAFF AND FLARE) DISPENSED BY THE AN/ALE-47 COUNTER-MEASURES DISPENSING SYSTEM DECEIVE WHAT TWO ANTI-AIRCRAFT SYSTEMS? RADAR AND INFRARED SENSORS

MAINT /s/ DOSS /s/ OPS /s/ XO /s/

UNCLASSIFIED/
MSGID/GENADMIN/CMC WASHINGTON DC PPO POC//
SUBJ/OPREP-3 SIR/ VMM-364 / 01364 /
REF/A/DOC/CMC/MCO 3504.2_//
REF/B/TEL/ 082148ZJUN22
REF/C/DOC/CMC/OPNAVINST 3750.6_//
NARR/REF A IS MCO ON OPREP-3 SIR: SERIOUS INCIDENT REPORTS. REF B IS VOICE
REPORT MADE TO THE MCOC BY REF C IS THE NAVY INSTRUCTION ON THE
NAVAL AVIATION SAFETY PROGRAM. //
UNIT POC/ MAJ/OPERATIONS/COMM: /DSN: /EMAIL:
//
POC/1/ /MAJ/EXECUTIVE OFFICER/COMM: /DSN:
/EMAIL: /

GENTEXT/REMARKS/1. DURING A TRAINING FLIGHT, 2 X MV-22B WERE CONDUCTING TAIL
GUNNERY PRACTICE IN THE R-2512 RANGE COMPLEX AT THE INKEY BARLEY TARGET IVO
EL CENTRO, CA. THE -2 AIRCRAFT LOST SIGHT OF THE LEAD AIRCRAFT AND
SUBSEQUENTLY NOTED SMOKE AND DEBRIS EVIDENCE OF A CRASH IN THE VICINITY OF
THE TARGET AREA. THE WINGMAN ASSUMED ON SCENE COMMANDER DUTIES. APPROXIMATELY
900 ROUNDS OF .50 CALIBER AMMUNITION REMAIN ONBOARD AIRCRAFT. LOCAL LAW
ENFORCEMENT IS AWARE AND ON SCENE.

2. 081930ZJUN22 // CONFIRMED 082148ZJUN22
3. R-2512 RANGE COMPLEX, INKEY BARLEY GUN TARGET

4. PERSONNEL INVOLVED

A. PILOT IN COMMAND

1. CAPT
2. LOSAPIO, NICHOLAS, P
3. / 7532
4. VMM-364
5. CAUCASIAN, MALE

B. CO-PILOT

1. CAPT
2. SAX, JOHN, J
3. / 7532
4. VMM-364
5. CAUCASIAN, MALE

C. CREW CHIEF

1. CPL
2. RASMUSON, SETH, D
3. / 6176
4. VMM-364
5. CAUCASIAN, MALE

D. CREW CHIEF

1. CPL
2. CARLSON, NATHAN, E
3. / 6176
4. VMM-364
5. CAUCASIAN, MALE

E. CREW CHIEF

1. LCPL
2. STRICKLAND, EVAN, A
3. / 6176
4. VMM-364
5. CAUCASIAN, MALE

5. 3D MAW COMMSTRAT HAS BEEN NOTIFIED. MEDIA INTEREST IS EXPECTED.

6. MAG-39 S-2 HAS BEEN NOTIFIED.

Enclosure (12)

Enclosure (4)

7. LOCAL AUTHORITIES HAVE BEEN NOTIFIED. INCIDENT IS CURRENTLY UNDER INVESTIGATION BY SQUADRON AMB. //

Enclosure (12)

Enclosure (4)



UNITED STATES MARINE CORPS
THIRD MARINE AIRCRAFT WING, FMF
MARINE CORPS AIR STATION MIRAMAR
P.O. BOX 452038
SAN DIEGO, CA 92145-2038

IN REPLY REFER TO
5830

24 Jun 22

From: /8042, USMC
To: Commanding General, 3d Marine Aircraft Wing, FMF
Subj: LINE OF DUTY PRELIMINARY INQUIRY INTO THE DEATH OF CORPORAL
NATHAN E. CARLSON /6176 USMC
Ref: (a) JAGINST 5800.7G CH-1
Encl: (1) Appointing Order
(2) Personnel Casualty Report dtd 9 June 22
(3) VMM-364 Flight Schedule dtd 8 June 22
(4) OPREP-3 Serious Incident Report dtd 8 Jun 22

1. This reports completion of the preliminary inquiry conducted in accordance with reference (a) into the death of Corporal Nathan E. Carlson /6176 USMC on 8 June 2022.

2. Personnel contacted:

- a. , USMC, Staff Secretary, 3d Marine Aircraft Wing.
- b. , USMC, Executive Officer, VMM-364,

3. Materials reviewed: Enclosures (1)-(4) were reviewed and all original copies are maintained by the Third Marine Aircraft Wing Office of the Staff Judge Advocate.

4. Summary of findings:

a. Paragraph 0215 of the reference states that a death incurred by a Marine on active duty is presumed to be “in the line of duty.” This presumption can only be overcome by “clear and convincing” evidence that certain circumstances existed at the time of death.

b. On 08 June 2022 Corporal Carlson was on active duty in the United States Marine Corps, assigned to Marine Medium Tiltrotor Squadron 364 (VMM-364), Marine Aircraft Group 39 (MAG-39), 3d Marine Aircraft Wing (3d MAW), enclosure (2).

c. The Commanding Officer, VMM-364, MAG-39, 3d MAW, authorized a rear mounted weapon system (RMWS) training mission comprised of two Marine Medium Tiltrotor (MV-22B) aircraft in the R-2512 range complex near El Centro, California on 08 June 2022, enclosures (3) and (4). Corporal Carlson was a member of the flight crew of the aircraft identified as Swift 11 in enclosure (3).

Enclosure (13)

Subj: LINE OF DUTY PRELIMINARY INQUIRY INTO THE DEATH OF CORPORAL
NATHAN E. CARLSON /6176 USMC

d. Prior to the launch of the mission, the flight crews were briefed on the mission and conditions, and an Operational Risk Management assessment was conducted to ensure the safety of all personnel associated with the mission.

e. At approximately 1230 hours on 8 June 2022 Swift 12 lost sight of Swift 11. The pilot and crew from Swift 12 noted smoke and, upon closer inspection, evidence of a crash by Swift 11 in the R-2512 range complex in the vicinity of El Centro, CA. Enclosure (4).

f. The Imperial County Coroner's Office pronounced all pilots and crew of Swift 11 dead on 8 June 2022. Enclosure (2).

g. There is no evidence indicating any misconduct, intoxication or drug abuse in this case.

5. Recommendation: I recommend that Corporal Nathan E. Carlson be found to have died in the line of duty and not due to the member's own misconduct

Controlled by: Department of the Navy
Controlled by: OSJA, 3d MAW (USMC)

POC: SJA, 3d MAW



UNITED STATES MARINE CORPS,

THIRD MARINE AIRCRAFT WING, FMF
MARINE CORPS AIR STATION MIRAMAR
P.O. BOX 452038
SAN DIEGO CA 92145-2038

IN REPLY REFER TO:
5830
OSJA
13 Jun 22

From: Commanding General, 3d Marine Aircraft Wing, FMF
To: USMC

Subj: COMMAND INVESTIGATION INTO THE CLASS A AVIATION MISHAP THAT
OCCURRED ON 08 JUNE 2022 IN THE R-2512 RANGE COMPLEX

Ref: (a) 10 U.S. Code, Section 2255
(b) JAGINST 5800.7G w/CH I (JAGMAN)

1. This Command Investigation (CI) is convened to investigate the circumstances surrounding a Class A aviation mishap in compliance with reference (a).
2. This letter appoints you in accordance with the references to investigate the cause and responsibility for the subject aviation mishap, the fatalities, description of all damage to property, and any attendant circumstances.
3. You are to complete both a line of duty determination Preliminary Inquiry (PI) and a Class A aviation mishap CI. Chapter II, Appendix A-2-k, and Appendix A-2-n of reference (b) are your governing reference materials. Templates for your PI and CI can be found at Appendix A-2-c and A-2-e, respectively.
 - a. You shall report your PI in writing by 14 calendar days from the date of this letter. If you require additional time, you shall submit a written request for such with detailed justification for any delay. Any request for extension shall be submitted via the 3d Marine Aircraft Wing's (3d MAW) Staff Judge Advocate (SJA). The request and associated response shall be included in your report.
 - b. You shall report your CI in writing by 60 calendar days from the date of this letter. If you require additional time, you shall submit a written request for such with detailed justification for the delay. Any request for extension shall be submitted via the 3d MAW SJA. The request and associated response shall be included in your report.
4. This is your primary duty until your PI and CI reports are completed, unless otherwise relieved of such duty by competent authority. Requests for additional support in your investigative efforts shall be submitted via the 3d MAW Chief of Staff. You are granted direct liaison authority with the senior member of the Aviation Mishap Board and with Naval Air Systems Command for requests related to this mishap.
5. You shall consult with the 3d MAW Director of Safety and Standardization and SJA on the conduct of your line of duty PI and aviation mishap CI.

Enclosure (13)

Enclosure (1)

Subj: COMMAND INVESTIGATION INTO THE CLASS A AVIATION MISHAP THAT
OCCURRED ON 08 JUNE 2022 IN THE R-2512 RANGE COMPLEX

6. By copy to: of this order, _____ are appointed
as your assistant investigating officers, unless otherwise relieved of such duties by competent
authority, to provide technical expertise on investigations.

7. The point of contact for this matter is the 3d MAW SJA, _____ at

Copy to:
CO, MAG-39
CO, VMM-364

From:
Sent: Wednesday, June 8, 2022 7:45 PM
To: Casualty PCR USMC - Deceased
Cc:

3MAW G-1 CASUALTY

Subject: Casualty Report - INIT - Carlson, Nathan - Incident Date/Time: 2022/06/08 12:00
Attachments: Carlson_Nathan_INIT_6-8-2022.rsf
Signed By:

***** CASUALTY REPORT *****

Report Type: INIT
Casualty Type: Nonhostile
Casualty Status: DECEASED
Casualty Category: Accident
Report Number: VMJ22004
Personnel Type: Regular
Personnel Affiliation: Active Duty
Personnel Category: Obligated/Voluntary Service
Last Name: Carlson
First Name: Nathan
Middle Name: Eric

Service: United States Marine Corps

Military Rank: CPL

Military Unit of Assignment: VMM 364

Date/Time of Incident (New/Old): 20220608/1200

Incident City: Holtville

Incident State: CA

Incident Country: United States

Circumstance: An MV-22 Osprey crashed while conducting training at Range-2512 IVO of Holtville, California at approximately 1200 on 20220608.

Died in/out of Medical Facility Treatment: Died Outside A Medical Treatment Facility

Date/Time of Death: 20220608/1200

Place of Death City: IVO Holtville

Place of Death State: CA

Place of Death Country: United States

Cause of Death: Pending

Duty Status: Present For Duty

Remarks: A Command Investigation will be initiated. SNM was declared deceased by

VMM-364, The unit point of contact is Executive Officer, , Office or . The PCR Verifier is Commanding Officer, VMM-364, , Office or

Software Version: DCIPS Forward - Version 8.0 Build: 70 Release Date: 01 May 2014

<DCIPS Forward 8.0>

AIK95XVQXJHYNTSC

AIKXVQGJLNSC

NSXJWY NSYT IKdHFXZFQY^ - HFXdWUYdNI1 NSNYdHFXdWUYdNI1 FWHMN[J1 HWJFYJidKWTR1
HWdZXJWdNI1 HWdiYR1 QRidZXJWdNI1 QRidYR1 WUYdY^UdYGI1 HFXdWUYdSW1
HFXdNSNYdWUYdSW1 HFXdHFXJdHQXdY1 HN[dJRudY^UJdHI1 HFXdNSHNISYdHI1
HFXdXYFYdFG1 HFXdHFYdHI1 XUHdNSY1 XUHdHFY1 YJWWdFHY1 HFXdUW[XdXYFYdHI1
HFXdUW[XdHFYdHI1 RZQYdHFXdJ[JSYdHI1 RZQYdHFXdJ[JSYdY]1 UJWXdY^UJdHI1
UJWXdRNQFKQdHI1 UJWXdHFYdHI1 NSidXXS1 TQIdNSidXXS1 NSIN[dQFXyDSR1
NSIN[dKNWXYdSR1 NSIN[dRNIIQJdSR1 NSIN[dSRdXK]dFG1 X[HdRGWdWFSPdFG1
NSidWFHJdUTUdHI1 NSidJYMSNHdHI1 NSidXJ]dHTIJ1 NSidWJQdIJSTRdHI1
ZSNKIdX[HdHI1 IRTX1 RNQdUJWXdHQFXdHI1 I^dUWHdHRXsidTKK1 HN[dUF^dLWdQ[QdSW1
HN[dUF^dUQFSdHI1 TWLZdSRJ1 ZSNYdNIJSYdHI1 FYLdUJGI1 GFXI1 GNWYMDIY1
NSidGWYMDHNY^dSR1 NSidGWYMDXYFdHI1 NSidGWYMDHYW^dHI1 HFXdUWTLSTXNXdHI1
MTXUdSR1 MTXUdH^dSR1 MTXUdXY1 MTXUdHYW^1 ILdYJ]Y1 UWTLSTXNXdY]1
INFLSTXNXdY]1 IXGQ^dWJYdQNXyDHI1 RNQdXUdY1 RNQdIWQdY1 NSidIXGQ^dUHYdSW1
XLQNdY1 HFXdiYMDKFHY^UdHI1 NSidMTWdH^dSR1 NSidMTWdXYdHI1 NSidMTWdHYW^dHI1
HTSYdMTXU_YSdNSdHI1 TWLFSN_FYNTSdSR1 HFXdNSHSYdYSLdHI1 HFXdNSKdKHdYUdHI1
JRWLdSYKSdW[diY1 JRWLdSYKSdHTRUQdiY1 NSidIJFYMDIY1 NSidIYMDMTXUdSR1
NSidIYMDHNY^dSR1 NSidIYMDXYFdHI1 NSidIYMDHYW^dHI1 [JMdT\SidHI1 [JMdWTQJdHI1
HFXdQTidNSdWVdHI1 HFXdGJSJdXYFYdHI1 HFXdGJSJdXYdY1 HFXdGJSJdJSidY1 HFXdiY1
TQIdHFXdY1 HFXdHNY^dSR1 HFXdZXdXYFdHI1 HFXdHYW^dHI1 MNLMdRNQdWFSPdFG1
MNLMdRNQdWFSPdJSidY1 MNLMdRNQdWFSPdXYdY1 WHRidRNQdWFSPdFG1 UWTRdQXYdY1
HFXdUWTHdNSKTdY]dHNWH1 HFXdUWTHdNSKTdY]dHFZX1 HFXdWRPXdY]1 [JMdLWUdHI1
[JMdHI1 [JMdXZUdHI1 \FwDHTSKQNHdHI1 TUXdNSHNISYdHI1 HFXdJ[JSYdY^UdHI1
WUYdY^UJdHI1 XZUdX[HdHI1 WH[^dXNYJdZYRdSW1 HFXdQFYdQTS1 HFXdFIWdQTHdY]1
HFXdRJIUWTLdHI1 NSidHY_UdHYW^dHI1 URTX1 HTSYdFLJSH^1 WHdYTZWdXYWYdY1
WHdYTZWdHRUQdY1 WHdYTZWdY^UdHI1 HFXdWRdNRdWH[W^dHI1 IHNUXdHFXdNSHSYdSW1
IHNUXdHFXdKFRdRGWdSW1 JINUN . XJQJHY INXYNSHY -XJQJHY RF]-HFXdWUYdNI. 0 6
KWTR IKdHFXZFQY^ .1 -XJQJHY RF]-HFXdWUYdNI. 0 6 KWTR IKdHFXZFQY^ .1 ,,1
,MFXy^,1 ,IHNUXK|i,1 ,75775;5=6::=,1 ,IHNUXK|i,1 ,75775;5=6>8,,1 ,N,1
,[RO77559,1 ,,1 ,,1 ,,1 ,S,1 ,l,1 ,F,1 ,,1 ,,1 ,,1 ,,1 ,,1 ,,1 ,,1 ,,1 ,W,1 ,F,1
,H,1 ,88;>=<;77,1 ,,1 ,Hfwqxts,1 ,Sfymfs,1 ,Jwnh,1 ,,1 ,HUQ,1 ,,1 ,,1 ,,1
,,1 ,R,1 ,,1 ,,1 ,,1 ,,1 ,,1 ,[RR 8;9,1 ,,1 ,,1 ,,1 ,,1 ,,1 ,,1 ,,1 ,,1
,,1 ,,1 ,,1 ,,1 ,,1 ,,1 ,,1 ,,1 ,,1 ,l,1 ,,1 ,,1 ,,1 ,,1 ,,1 ,,1
,,1 ,,1 ,75775;5=6755,1 ,,1 ,N[T Mtqy{nqqj,1 ,HF,1 ,ZX,1 ,,1 ,,1 ,,1 ,UI^,1
,,1 ,,1 ,75775;5=6755,1 ,,1 ,Mtqy{nqqj,1 ,HF,1 ,ZX,1 ,,1 ,,1 ,,1 ,,1 ,Fs
R[277 Txuwj~ hwfmxji |mnqj htsizhynsl ywfnsnsl fy Wfslj27:67 N[T tk
Mtqy{nqqj1 Hfqntksnf fy fuuwt}nrifyjq~ 6755 ts 75775;5=3,1 ,Ujsinsl,1 ,F
Htrrfsi Ns{jxynlfynts |nqq gj nsnyfyji3 XSR |fx ijhqfwji ijhfxji g~
Htrujyjsy Rjinhfq Fzymtwny~ Rnpj Rnxynwj1 Nrujwnfq Htzy~ Htwtsjw -<;5.
88>2;8663 Ymj zsn y utnsy tk htsyfy nx J}jhzyn{j Tkknhjw1 [RR28;91 Rfotw
Gwnfs U3 Xuttsjw1 Tkknhj -<;5. <;8269=8 tw gwnfs3u3xuttsjwEzxr3rnq3 Ymj UHW
[jwnknjw nx Htrrfsinl Tkknhjw1 [RR28;91 Qnjzyjsfsy Htqtsjq Otms H3 Rnqqjw1
Tkknhj ->59. 7>92757= tw otms3h3rnqqjw9Ezxr3rnq3,1 ,,1 ,,1 ,,1 ,,1 ,,1
,N,1 ,,1 ,,1 ,,1 ,,1 ,,1 ,,1 ,,1 ,,1 ,,1 ,,1 ,S,1 ,,1 ,,1 ,6:9:9:<559,
KWTR IKdHFXZFQY^

AIKXVQJSIC

ATWFXVQGJLNSC

NSXJWY NSYT IKdHFXZFQY^- HFXdWUYdNI1 NSNYdHFXdWUYdNI1 FWHMN[J1 HWdZXJWdNI1
HWdiYYR1 QRidZXJWdNI1 QRIdiYYR1 WUYdY^UdYGI1 HFXdWUYdSW1 HFXdNSNYdWUYdSW1
HFXdHFXJdHQXdIY1 HN[dJRUDY^UJdHI1 HFXdNSHNISYdHI1 HFXdXYFYdFG1 HFXdHFYdHI1
XUHdNSY1 XUHdHFY1 YJWWdFHY1 RZQYdHFXdJ[JSYdHI1 RZQYdHFXdJ[JSYdY]1
UJWXdY^UJdHI1 UJWXdRNQFKQdHI1 UJWXdHFYdHI1 NSIdXXS1 TQIdNSIdXXS1
NSIN[dQFXyDSR1 NSIN[dKNWXYdSR1 NSIN[dRNIIQJdSR1 NSIN[dSRdXK]dFG1
X[HdRGWdWFSPdFG1 NSIdWFHJdUTUdHI1 NSIdJYMSNHdHI1 NSIdXJ]dHTIJ1
NSIdWJQdIJSTRdHI1 ZSNKIdX[HdHI1 IRTX1 RNQdUJWXdHQFXdHI1 I^dUWHdHRXSIDTKK1
HN[dUF^dLWdQ[QdSW1 HN[dUF^dUQFSdHI1 TWLZdSRJ1 ZSNYdNIJSYdHI1 FYLdUJGI1 GFXI1
GNWYMDIY1 NSIdGWYMDHNY^dSR1 NSIdGWYMDXYFdHI1 NSIdGWYMDHYW^dHI1
HFXdUWTLSTXNXdHI1 MTXUdSR1 MTXUdH^dSR1 MTXUdXY1 MTXUdHYW^1 ILdYJ]Y1
UWTLSTXNXdY]1 INFLSTXNXdY]1 IXGQ^dWJYdQNXyDHI1 RNQdXUdIY1 RNQdIWQdIY1
NSIdIXGQ^dUHYdSW1 XLQNdIY1 HFXdIYMdKFHY^UdHI1 NSIdMTWdH^dSR1 NSIdMTWdXYdHI1
NSIdMTWdHYW^dHI1 HTSYdMTXU_YSdNSdHI1 TWLFSN_FYNTSdSR1 HFXdNSHSYdYSLdHI1
HFXdNSKdKHdYUdHI1 JRWLdSYKdW[\dIY1 JRWLdSYKdHTRUQdIY1 NSIdIJFYMDIY1
NSIdIYMDMTXUdSR1 NSIdIYMDHNY^dSR1 NSIdIYMDXYFdHI1 NSIdIYMDHYW^dHI1
[JMdT\SIdHI1 [JMdWTQJdHI1 HFXdQTIdNSdWVdHI1 HFXdGJSJdXYFYdHI1
HFXdGJSJdXYdIY1 HFXdGJSJdSIdIY1 HFXdIY1 TQIdHFXdIY1 HFXdHNY^dSR1
HFXdZXdXYFdHI1 HFXdHYW^dHI1 MNLMdRNQdWFSPdFG1 MNLMdRNQdWFSPdJSIdIY1
MNLMdRNQdWFSPdXYdIY1 WHRIdRNQdWFSPdFG1 UWTRdQXYdIY1 HFXdUWTHdNSKTdY]dHNWH1
HFXdUWTHdNSKTdY]dHFZX1 HFXdWRPXdY]1 [JMdLWUdHI1 [JMdHI1 [JMdXZUUdHI1
\FWdHTSKQNHdHI1 TUXdNSHNISYdHI1 HFXdJ[JSYdY^UdHI1 WUYdY^UJdHI1
XZUUdX[HdHI1 WH[^dXNYJdZYRdSW1 HFXdQFYdQTS1 HFXdFIWdQTHdY]1
HFXdRJIdUWTLdHI1 NSIdHY_UdHYW^dHI1 URTX1 HTSYWdFLJSH^1 WHdYTZWdXYWYdIY1
WHdYTZWdHRUQdIY1 WHdYTZWdY^UdHI1 HFXdWRdNRdWH[W^dHI1 IHNUXdHFXdNSHSYdSW1
IHNUXdHFXdKFRdRGWdSW1 JINUN . [FQZJX - hfxdwuydni3sj}y{fq1
hfxdwuydni3sj}y{fq1 ,,1 ,IHNUXK|i,1 YTdIFYJ-,5=2ozs27577 6::=,1 ,ii2rts2~~~~
mm79?rn,,1 ,IHNUXK|i,1 YTdIFYJ-,5=2ozs27577 6>8;,1 ,ii2rts2~~~~ mm79?rn,,1
,N,1 ,[RO77559,1 ,,1 szqq1 ,,1 ,S,1 ,l,1 ,F,1 ,,1 ,,1 ,,1 ,,1 ,,1 ,W,1 ,F,1
,H,1 ,88;>=<;77,1 ,,1 ,Hfwqxts,1 ,Sfymfs,1 ,Jwnh,1 ,,1 ,HUQ,1 ,,1 ,,1 ,,1
,,1 ,R,1 ,,1 ,,1 ,,1 ,,1 ,,1 ,[RR 8;9,1 ,,1 szqq1 szqq1 szqq1 ,,1 ,,1 ,,1
,,1 ,,1 ,,1 ,,1 ,,1 ,,1 ,,1 ,,1 szqq1 szqq1 ,,1 szqq1 ,l,1 ,,1 ,,1 ,,1
,,1 ,,1 ,,1 ,,1 szqq1 szqq1 YTdIFYJ-,5=2ozs27577 6755,1 ,ii2rts2~~~~
mm79?rn,,1 ,,1 ,N[T Mtqy{nqqj,1 ,HF,1 ,ZX,1 ,,1 ,,1 ,,1 ,UI^,1 szqq1 szqq1
YTdIFYJ-,5=2ozs27577 6755,1 ,ii2rts2~~~~ mm79?rn,,1 szqq1 ,Mtqy{nqqj,1 ,HF,1
,ZX,1 ,,1 szqq1 szqq1 ,,1 szqq1 ,Fs R[277 Txuwj~ hwfxmji |mnqj htsizhynsl
ywfnsnsl fy Wfslj27:67 N[T tk Mtqy{nqqj1 Hfqnktsnf fy fuuwt}nrftyj~ 6755 ts
75775;5=3,1 ,Ujsinsl,1 ,F Htrrfsi Ns{jxynlfynts |nqq gj nsynfyji3 XSR |fx
ijhqfwi ijhfjxi g~ Htrujyjsy Rjinhfq Fzymtwny~ Rnpj Rnxywnjq1 Nrujwnfq
Htzy~ Htwtsjw -<;5. 88>2;8663 Ymj zsn y utnsy tk htsyfhy nx J}jhzyn{j
Tkknhjw1 [RR28;91 Rfotw Gwnfs U3 Xuttsjw1 Tkknhj -<;5. <;8269=8 tw
gwnfs3u3xuttsjwEzxr3rnq3 Ymj UHW [jwnknjw nx Htrrfsinl Tkknhjw1 [RR28;91
Qnjzysfsy Htqtsjq Otms H3 Rnqqjw1 Tkknhj ->59. 7>92757= tw
otms3h3rnqqjw9Ezxr3rnq3,1 ,,1 ,,1 ,,1 ,,1 ,,1 ,,1 ,N,1 ,,1 ,,1 ,,1 ,,1
,,1 ,,1 ,,1 szqq1 szqq1 ,,1 ,S,1 ,,1 ,,1 ,6:9:9:<559,.

ATWFXVQJSIC

AXVQC

NSXJWY NSYT IHNUXK\I- WUYdY^UdYGI1 HFXdNSHNISYdHI1 HFXdXYFYdFG1 HFXdHFYdHI1
HFXdWUYdSW1 RZQYdHFXdJ[JSYdHI1 RZQYdHFXdJ[JSYdY]1 UJWXdY^UJdHI1
UJWXdRNQFKQdHI1 UJWXdHFYdHI1 NSIdXXS1 TQIdNSIdXXS1 NSIN[dQFXyDSR1
NSIN[dKNWXYdSR1 NSIN[dRNIIQJdSR1 NSIN[dSRdXK]dFG1 NSIdZSNKIdX[HdHI1
X[HdRGWdWFSPdHI1 TWLZdSRJ1 HFXdGJSJdXYFYdHI1 HFXdIY1 TQIdHFXdIY1
HFXdNSKdKHdYUdHI1 HFXdHNY^dSR1 HFXdZXdXYFdHI1 HFXdHYW^dHI1 NSIdIJFYMdY1
HFXdIYMdKFHdY^UdHI1 NSIdIYMdHNY^dSR1 NSIdIYMdXYFdHI1 NSIdIYMdHYW^dHI1
HFXdWRdNRdWH[W^dHI1 INFLSTXNXdY]1 HFXdUWTHdNSKTdY]dHNWH1
HFXdUWTHdNSKTdY]dHFZX1 HFXdWRPXdY]1 HFXdHFJdHQXdYdYGI1 XUFWJ5:1 MTXUdSR1
MTXUdH^dSR1 MTXUdHYW^1 MTXUdXY1 UWTLSTXNXdY]1 HFXdUWTLSTXNXdHIdYGI . [FQZJX
- ,NSNY,1 ,S,1 ,I,1 ,F,1 ,[RO77559,1 ,,1 ,,1 ,W,1 ,F,1 ,H,1 ,88;>=<;77,1 ,,1
,Hfwqxts,1 ,Sfymfs,1 ,Jwnh,1 ,,1 ,R,1 ,HUQ,1 ,[RR 8;9,1 ,UI^,1
,75775;5=6755,1 ,,1 ,,1 ,Mtqy{nqqj,1 ,HF,1 ,ZX,1 ,75775;5=6755,1 ,I,1 ,N[T
Mtqy{nqqj,1 ,HF,1 ,ZX,1 ,S,1 ,,1 ,Fs R[277 Txuwj~ hwfxmji |mnqj htsizhynsl
ywfnsnsl fy Wfslj27:67 N[T tk Mtqy{nqqj1 Hfqntwsnf fy fuuwt}nrfyjq~ 6755 ts
75775;5=3,1 ,Ujsinsl,1 ,F Htrrfsi Ns{jxynlfynts |nqq gj nsynfyji3 XSR |fx
ijhqfwji ijhfjxi g~ Htrujyjsy Rjinhfq Fzymtwny~ Rnpj Rnxywnjq1 Nrujwnfq
Htzy~ Htwtsjw -<;5. 88>2;8663 Ymj zsnv utnsy tk htsyfhy nx J}jhzyn{j
Tkknhjw1 [RR28;91 Rfotw Gwnfs U3 Xuttsjw1 Tkknhj -<;5. <;8269=8 tw
gwnfs3u3xuttsjwEzxr3rnq3 Ymj UHW [jwnknjw nx Htrrfinsl Tkknhjw1 [RR28;91
Qnzyjsfsy Htqtsjq Otms H3 Rnqqjw1 Tkknhj ->59. 7>92757= tw
otms3h3rnqqjw9Ezxr3rnq3,1 ,,1 ,IHNUXK|i,1 ,,1 ,,1 ,,1 ,,1 ,,1 ,,1 ,,
AJSIC



UNITED STATES MARINE CORPS
MARINE MEDIUM TILTROTOR SQUADRON 364
MARINE AIRCRAFT GROUP 39
CAMP PENDLETON
PO BOX 555931



Remember OPSEC is everyone's responsibility, keep our information secure!

Wednesday, 8 June, 2022 (22159)

DUTIES	TIMES	KNFG	LPOD	SCHEDULED	SBTB	FY								
SDO:		AIRFIELD HOURS: 0900-0100	0045	MV-228 20 28.0	JUNE QTR									
SDC:		HOT FUEL: 1100-2300		Total 20 28.0	FCST/ACT	FCST/ACT								
DNCO:		COLD FUEL: 0700-2345			260.0/66.5	2368.0/1370.2								
ADNCO:		QUIET HOURS: NONE												
ODO:	0530-1200	NITEX: 2101-0100												
	1200-1830													
	1830-LPOD													
SKED:														
KNFG: U (-7)	BMNT:	0436	SR/SS:	0540/1958	EENT:	2102	MR/MS:	1352/0150	ILLUM:	55%	LLL:	0117-0420	HLL:	0420-0436 2102-0153*

EVENT	TMS	CALLSIGN	BRF/ETD/ETA	ICAO	CREW	FLIGHTS	TMR	MSN	SBTP	CONFIG	NOTES
7101	MV-228	SWIFT 01	0830/TBA/TBA NET: 0700	KNFG/KNFG			2030 2030 2240	FCF	0/0.0		
7111	MV-228	SWIFT 11	0600/0800/1330	KNFG/KNFG	SL Capt Losapio Capt Sax Cpl Rasmuson Cpl Carlson LCpl Strickland	2140 2242 2280 2281 2282 2541 2640 6240 6900 2140 2242 2280 2281 2282 2541 2640 6900 2142 2240 2282 2541 2640 6351 6900 2140 2242 2282 2541 2640 5630X,6351 900 2140X,2240X,2242X,2640X	1A1 1A3 1B1	DAY LAT / TG / RVLS / LATI	4/5.0	FUEL: 11.0 2 X GAU-21 1200 RDS .50 CAL	1
7112	MV-228	SWIFT 12	0600/0800/1330	KNFG/KNFG		2140 2242 2280 2281 2282 2541 2640 6900 2140 2242 2280 2281 2282 2541 2640 6900 2140 2242 2282 2541 2640 6351 6900 2140 2242 2282 2541 2640 5631X 6351 6900 2140X,2240X,2242X,2640X	1A1 1A3 1B1	DAY LAT / TG / RVLS / LATI	4/5.0	FUEL: 11.0 2 X GAU-21 1200 RDS .50 CAL	1
7121	MV-228	SWIFT 21	1100/1400/1900 NET: 0800	KNFG/KNFG	SL	2242 2280 2281 2282 4140 4580 6240 6900 2242 2280 2281 2282 4140X 4580X 6900 2242 2282 4140 4580 6900 2242 2282 4140 4580 6900	1A9	CALS / RVLS / FASTROPE	3/4.5	FUEL: 11.0 2 X POMMEL	2
7122	MV-228	SWIFT 22	1100/1400/1900 NET: 0800	KNFG/KNFG		2242 2280 2281 2282 4140 4580 6900 2242 2280 2281 2282 4140X ,6900 2242 2282 4140 4580 6900 2242 2282 4140X,4580X 6900	1A9	CALS / RVLS / FASTROPE	3/4.5	FUEL: 11.0 2 X POMMEL	2
7131	MV-228	SWIFT 31	1645/1945/0045 NET: 1515	KNFG/KNFG	SL	2280 2281 2282 2341 2543 3441 4083 4840 6240 6900 2280 2281 2282 2341 2543 3441 6900 2280 2281 2282 2341 4083X,4840 6900 2280 2281 2282 2341 4083X,4840 6900 2282 2341 2543 3441 4083 4840 6351 6900 2282 2341 2543 3441 4083X 4840 6350X 6900 2282 2341 6900	1A9	CAT / NS EXTERNALS / HLL CAL / RVLS / NS TG	3/4.5	FUEL: 11.0 2 X GAU-21 1200 RDS .50 CAL 2 X PENDANT	3
7132	MV-228	SWIFT 32	1645/1945/0045 NET: 1515	KNFG/KNFG		2280 2281 2282 2341 2543 3441 6900 2280 2281 2282 2341 2543 3441 6900 2340X,2543X 2282 2341 2543 3441 6351 6900 2282 2341 2542 6350X 6900	1A9	CAT / NS EXTERNALS / HLL CAL / RVLS / NS TG	3/4.5	FUEL: 11.0 2 X GAU-21 1200 RDS .50 CAL 2 X PENDANT	3

MAINTENANCE NOTES:

Max A/C: 3
 ST 11/12: 1 B/U
 ST 21/22: 1 B/U if not used by ST 11/12
 ST31/32: 1 B/U if not used by ST 21/22

FLIGHT NOTES:

1. Route: KNFG-VR 1268-Rice-KHII-VR 289-Inkey Barley-KNFG. R-2512 reserved 1200-1300L. Rice deconflicted 0900-1100L. CTO PPR 08-NH-01. Able East reserved 0830-0930L. VR-1268 reserved A-D 1545-1615Z. VR-289 reserved A-E 1815-1845Z.
 2. Route: KNFG-L2 Roadrunner-KNFG.Fastrope with V1/4 in TA Sierra 3. 70 Pax slick. POC
 3. Route: KNFG-LHD PAD-TALA-KNFG-CACTUS WEST-KNFG. LHD PAD co-use with HMLA-169. KNFG Range 2000-2200L. Whiskey Impact area reserved 2200-2300L. NS External with CLB 15 in TALA. POC TALA reserved 2000-0000L. Flight brief conducted with HMLA-169 on 7 June.

GROUND EVENTS:

START	END	SUBJECT	LOCATION	POC	PERSONNEL	NOTES
0700	0715	FOD WALK	HANGAR		ALL AVAILABLE PERSONNEL	
0700	0715	MAINTENANCE MEETING	MAINTENANCE CONTROL		ALL MAINTENANCE PERSONNEL	
0730	0800	CO STANDUP	CO'S CONFERENCE ROOM			
0900	1100	CRB	MAG-39 CONFERENCE ROOM			
1400	1500	DFT COA DECISION BRIEF	CO'S OFFICE			
1500	1530	SNCO MEETING	READY ROOM		ALL SNCOs	
1600	1615	MAINTENANCE MEETING	MAINTENANCE CONTROL		ALL MAINTENANCE PERSONNEL	

QUESTIONS OF THE DAY

1. EP:
 - PRTR OVERTORQUE (E2-4-5)
 1. MANEUVER SEVERITY - REDUCE
 2. LAND AS SOON AS PRACTICAL
 NOTE: OVERTORQUES MAY CAUSE TORQUE SENSOR FAIL. PFCS RESET WILL BE REQUIRED TO CLEAR THE SENSOR FAILURES PRIOR TO CLEARING THE PRTR OVERTORQUE.
2. NATOPS: THE _____ ASSEMBLIES ARE DESIGNED TO REDUCE ROTOR-INDUCED 3/REV VIBRATIONS. PENDULUM DAMPENER
3. TACTICS: EXPENDABLES (CHAFF AND FLARE) DISPENSED BY THE AN/ALE-47 COUNTER-MEASURES DISPENSING SYSTEM DECEIVE WHAT TWO ANTI-AIRCRAFT SYSTEMS? RADAR AND INFRARED SENSORS

MAINT /s/ DOSS /s/ OPS /s/ XO /s/

UNCLASSIFIED/
MSGID/GENADMIN/CMC WASHINGTON DC PPO POC//
SUBJ/OPREP-3 SIR/ VMM-364 / 01364 /
REF/A/DOC/CMC/MCO 3504.2_//
REF/B/TEL/ /082148ZJUN22
REF/C/DOC/CMC/OPNAVINST 3750.6_//
NARR/REF A IS MCO ON OPREP-3 SIR: SERIOUS INCIDENT REPORTS. REF B IS VOICE
REPORT MADE TO THE MCOC BY REF C IS THE NAVY INSTRUCTION ON THE
NAVAL AVIATION SAFETY PROGRAM. //
UNIT POC/ MAJ/OPERATIONS/COMM: /DSN: /EMAIL:
//
POC/1/ /MAJ/EXECUTIVE OFFICER/COMM: /DSN:
/EMAIL: //

GENTEXT/REMARKS/1. DURING A TRAINING FLIGHT, 2 X MV-22B WERE CONDUCTING TAIL
GUNNERY PRACTICE IN THE R-2512 RANGE COMPLEX AT THE INKEY BARLEY TARGET IVO
EL CENTRO, CA. THE -2 AIRCRAFT LOST SIGHT OF THE LEAD AIRCRAFT AND
SUBSEQUENTLY NOTED SMOKE AND DEBRIS EVIDENCE OF A CRASH IN THE VICINITY OF
THE TARGET AREA. THE WINGMAN ASSUMED ON SCENE COMMANDER DUTIES. APPROXIMATELY
900 ROUNDS OF .50 CALIBER AMMUNITION REMAIN ONBOARD AIRCRAFT. LOCAL LAW
ENFORCEMENT IS AWARE AND ON SCENE.

2. 081930ZJUN22 // CONFIRMED 082148ZJUN22
3. R-2512 RANGE COMPLEX, INKEY BARLEY GUN TARGET
4. PERSONNEL INVOLVED

- A. PILOT IN COMMAND
 - 1. CAPT
 - 2. LOSAPIO, NICHOLAS, P
 - 3. / 7532
 - 4. VMM-364
 - 5. CAUCASIAN, MALE
- B. CO-PILOT
 - 1. CAPT
 - 2. SAX, JOHN, J
 - 3. / 7532
 - 4. VMM-364
 - 5. CAUCASIAN, MALE
- C. CREW CHIEF
 - 1. CPL
 - 2. RASMUSON, SETH, D
 - 3. / 6176
 - 4. VMM-364
 - 5. CAUCASIAN, MALE
- D. CREW CHIEF
 - 1. CPL
 - 2. CARLSON, NATHAN, E
 - 3. / 6176
 - 4. VMM-364
 - 5. CAUCASIAN, MALE
- E. CREW CHIEF
 - 1. LCPL
 - 2. STRICKLAND, EVAN, A
 - 3. / 6176
 - 4. VMM-364
 - 5. CAUCASIAN, MALE

5. 3D MAW COMMSTRAT HAS BEEN NOTIFIED. MEDIA INTEREST IS EXPECTED.
6. MAG-39 S-2 HAS BEEN NOTIFIED.

Enclosure (13)

Enclosure (4)

7. LOCAL AUTHORITIES HAVE BEEN NOTIFIED. INCIDENT IS CURRENTLY UNDER INVESTIGATION BY SQUADRON AMB. //

Enclosure (13)

Enclosure (4)



UNITED STATES MARINE CORPS
THIRD MARINE AIRCRAFT WING, FMF
MARINE CORPS AIR STATION MIRAMAR
P.O. BOX 452038
SAN DIEGO, CA 92145-2038

IN REPLY REFER TO
5830

24 Jun 22

From: /8042, USMC
To: Commanding General, 3d Marine Aircraft Wing, FMF
Subj: LINE OF DUTY PRELIMINARY INQUIRY INTO THE DEATH OF LANCE
CORPORAL EVAN A. STRICKLAND /6176 USMC
Ref: (a) JAGINST 5800.7G CH-1
Encl: (1) Appointing Order
(2) Personnel Casualty Report dtd 9 June 22
(3) VMM-364 Flight Schedule dtd 8 June 22
(4) OPREP-3 Serious Incident Report dtd 8 Jun 22

1. This reports completion of the preliminary inquiry conducted in accordance with reference (a) into the death of Lance Corporal Evan A. Strickland /6176 USMC on 8 June 2022.

2. Personnel contacted:

- a. USMC, Staff Secretary, 3d Marine Aircraft Wing,
- b. , USMC, Executive Officer, VMM-364,

3. Materials reviewed: Enclosures (1)-(4) were reviewed and all original copies are maintained by the Third Marine Aircraft Wing Office of the Staff Judge Advocate.

4. Summary of findings:

a. Paragraph 0215 of the reference states that a death incurred by a Marine on active duty is presumed to be “in the line of duty.” This presumption can only be overcome by “clear and convincing” evidence that certain circumstances existed at the time of death.

b. On 08 June 2022 Lance Corporal Strickland was on active duty in the United States Marine Corps, assigned to Marine Medium Tiltrotor Squadron 364 (VMM-364), Marine Aircraft Group 39 (MAG-39), 3d Marine Aircraft Wing (3d MAW), enclosure (2).

c. The Commanding Officer, VMM-364, MAG-39, 3d MAW, authorized a rear mounted weapon system (RMWS) training mission comprised of two Marine Medium Tiltrotor (MV-22B) aircraft in the R-2512 range complex near El Centro, California on 08 June 2022, enclosures (3) and (4). Lance Corporal Strickland was a member of the flight crew of the aircraft identified as Swift 11 in enclosure (3).

Enclosure (14)

Subj: LINE OF DUTY PRELIMINARY INQUIRY INTO THE DEATH OF LANCE
CORPORAL EVAN A. STRICKLAND /6176 USMC

d. Prior to the launch of the mission, the flight crews were briefed on the mission and conditions, and an Operational Risk Management assessment was conducted to ensure the safety of all personnel associated with the mission.

e. At approximately 1230 hours on 8 June 2022 Swift 12 lost sight of Swift 11. The pilot and crew from Swift 12 noted smoke and, upon closer inspection, evidence of a crash by Swift 11 in the R-2512 range complex in the vicinity of El Centro, CA. Enclosure (4).

f. The Imperial County Coroner's Office pronounced all pilots and crew of Swift 11 dead on 8 June 2022. Enclosure (2).

g. There is no evidence indicating any misconduct, intoxication or drug abuse in this case.

5. Recommendation: I recommend that Lance Corporal Evan A. Strickland be found to have died in the line of duty and not due to the member's own misconduct.

Controlled by: Department of the Navy
Controlled by: OSJA, 3d MAW (USMC)

POC: SJA, 3d MAW